

CESSNA 185 PARTS SHEET

Use this guide to help find and locate parts

Some parts on the sheets shown are grayed out because some

wing parts are also located on some fuselage sheets and visa versa.

For example, see and compare FUES PARTS SHEET-5 (pg 5) & WING PARTS SHEET-21 (pg 21)

FUES PARTS -----SHEET-1 thru SHEET-12

TAIL PARTS -----SHEET-13 thru SHEET-15

WING PARTS -----SHEET-16 thru SHEET-21

MISCH PARTS -----SHEET-22 and SHEET-23

OPTIONAL VORTEX WING TIPS-----SHEET-24

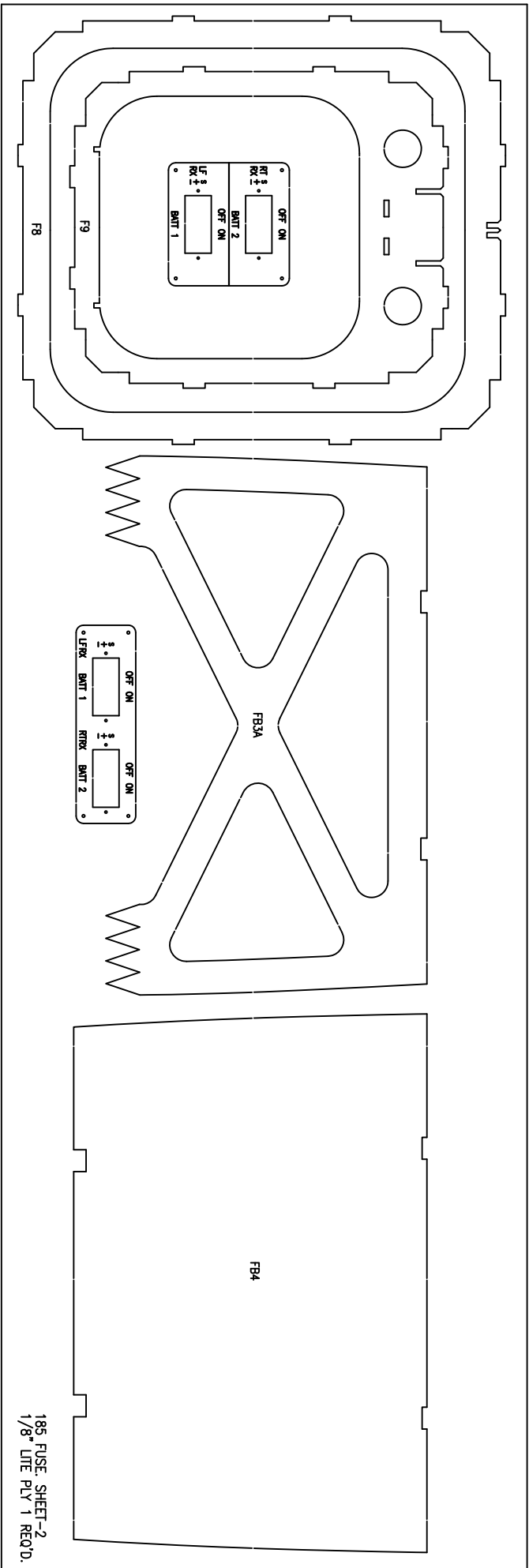
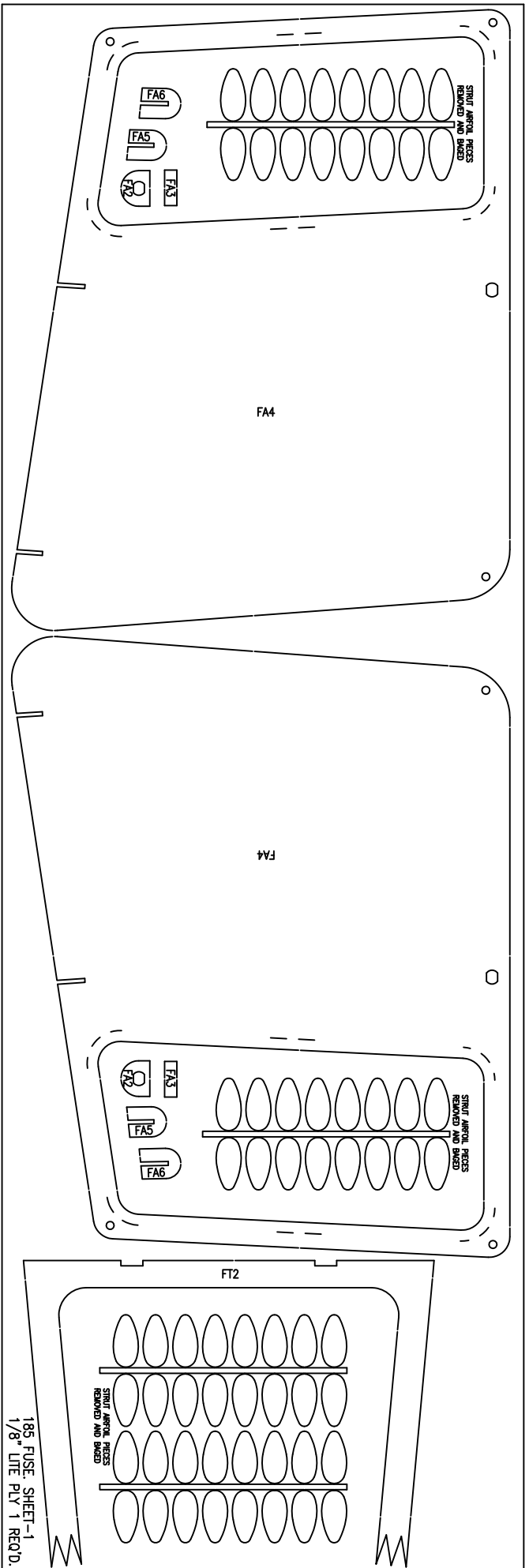

12" WIDE x 36" LONG x 1/8" THICK LITE PLY ONE (1) REQUIRED

185 FUSES PARTS SHEET-1

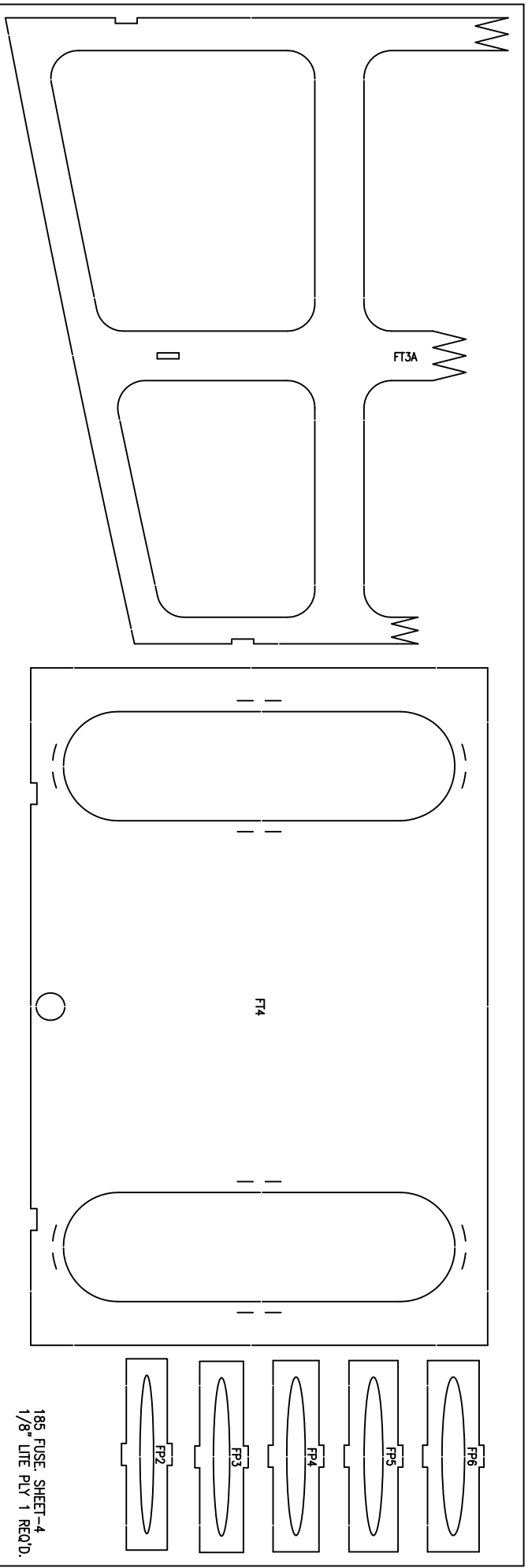
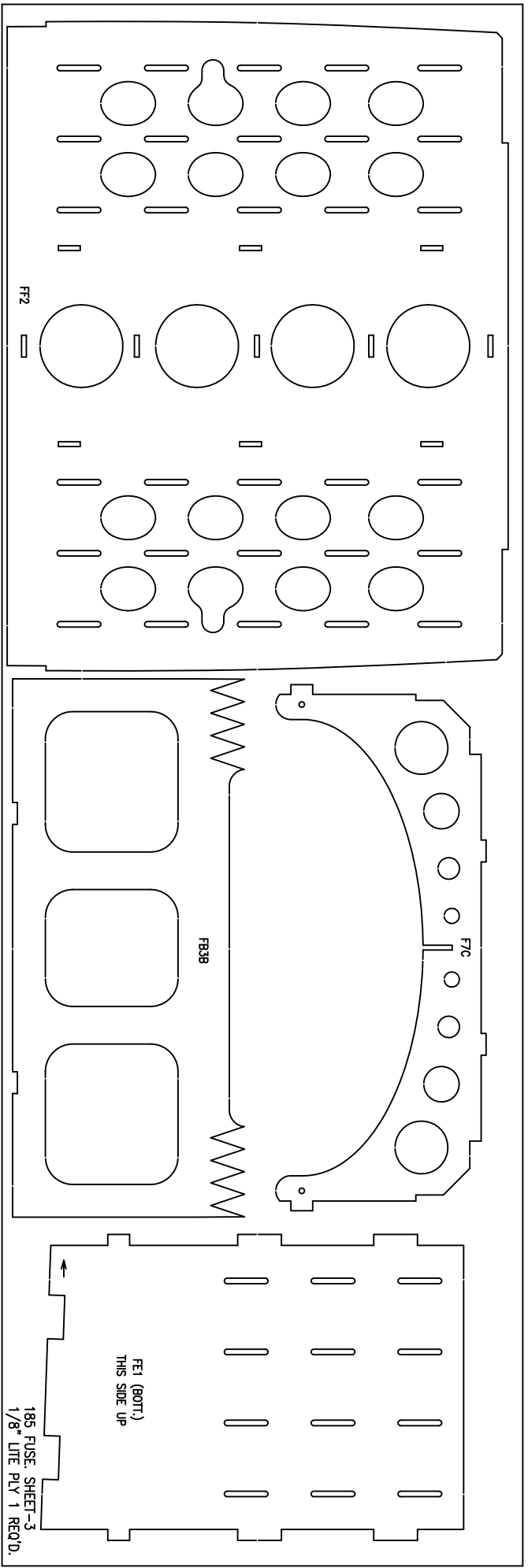

12" WIDE x 36" LONG x 1/8" THICK LITE PLY ONE (1) REQUIRED

185 FUSES PARTS SHEET-2

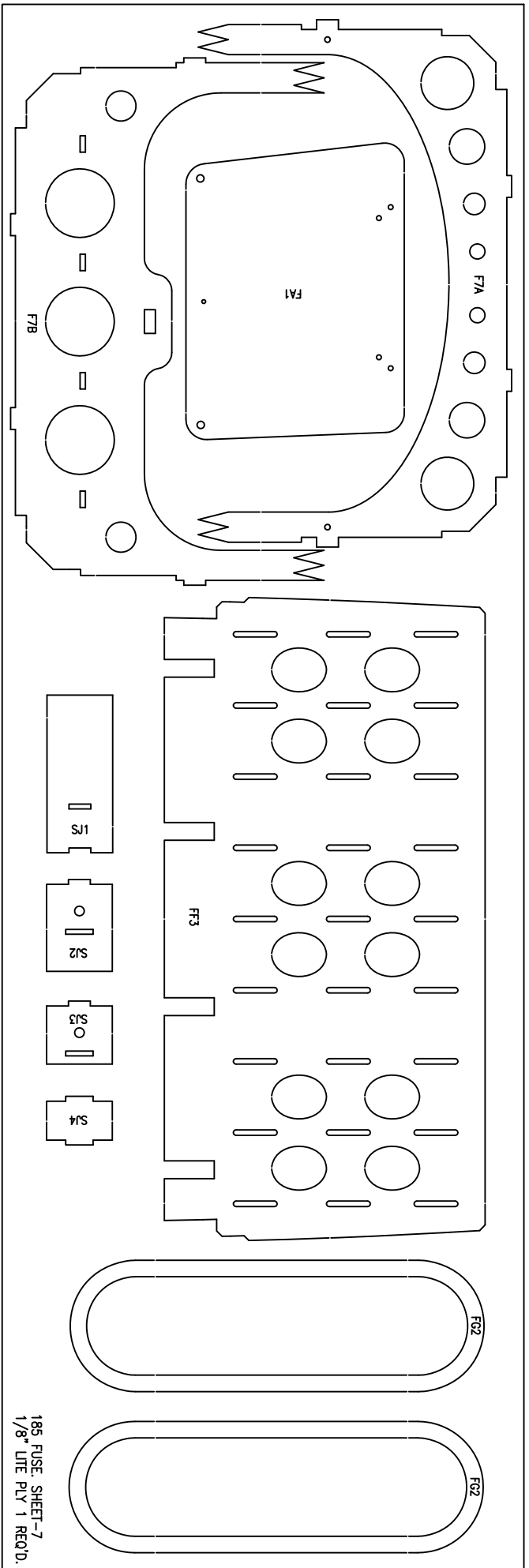

12" WIDE x 36" LONG x 1/8" THICK LITE PLY ONE (1) REQUIRED

185 FUSE SHEET-7
1/8" LITE PLY 1 REQ'D.

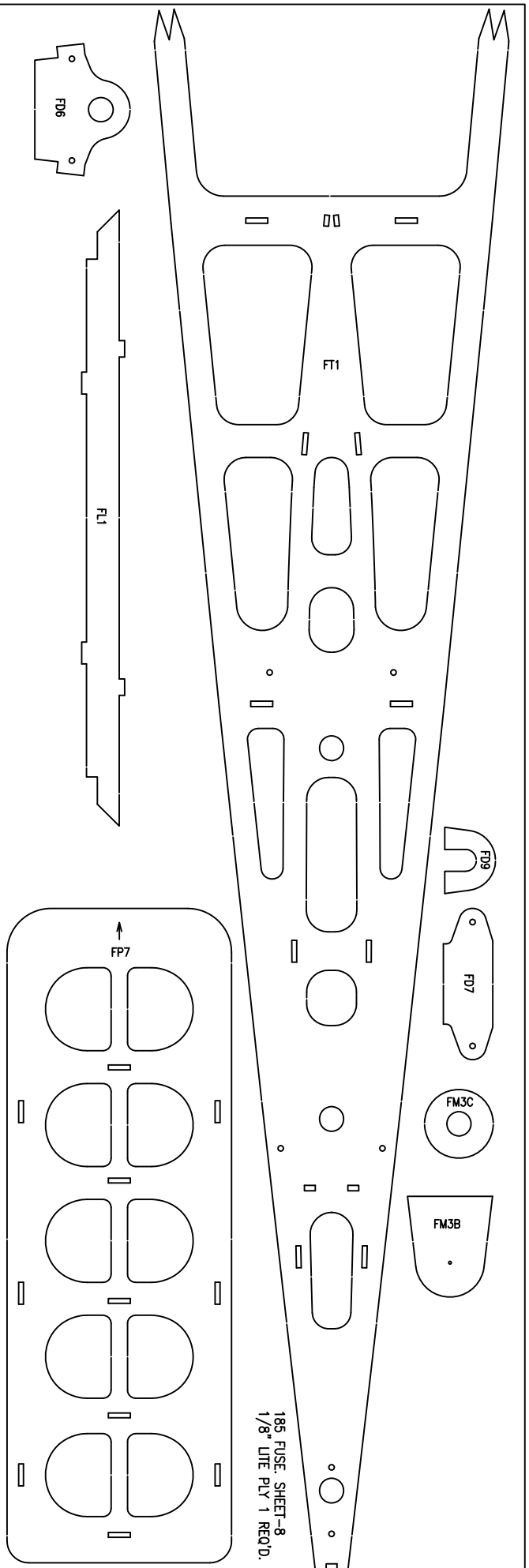

12" WIDE x 36" LONG x 1/8" THICK LITE PLY ONE (1) REQUIRED

185 FUSE SHEET-8
1/8" LITE PLY 1 REQ'D.

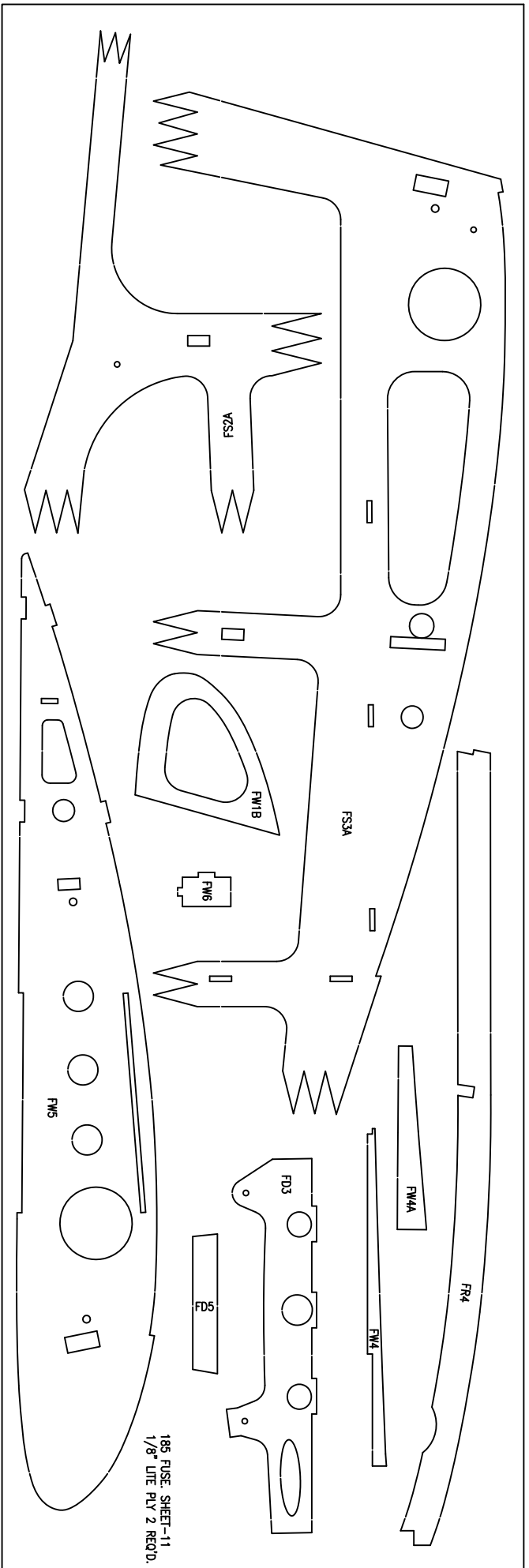

12" WIDE x 36" LONG x 1/8" THICK LITE PLY TWO (2) REQUIRED

185 FUSE SHEET-11
1/8" LITE PLY 2 REQ'D.

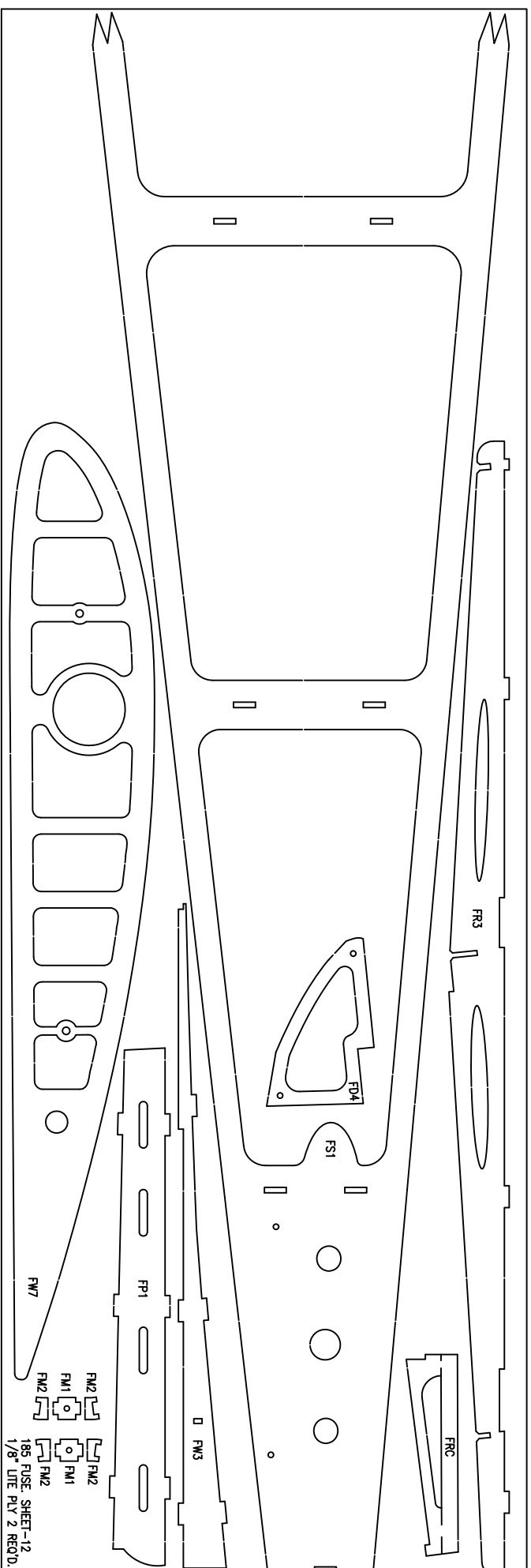

12" WIDE x 36" LONG x 1/8" THICK LITE PLY TWO (2) REQUIRED

185 FUSES PARTS SHEET-6

FR1
FR2
FR3
FR4
FR5
FR6
FR7
FR8
FR9
FR10
FR11
FR12
FR13
FR14
FR15
FR16
FR17
FR18
FR19
FR20
FR21
FR22
FR23
FR24
FR25
FR26
FR27
FR28
FR29
FR30
FR31
FR32
FR33
FR34
FR35
FR36
FR37
FR38
FR39
FR40
FR41
FR42
FR43
FR44
FR45
FR46
FR47
FR48
FR49
FR50
FR51
FR52
FR53
FR54
FR55
FR56
FR57
FR58
FR59
FR60
FR61
FR62
FR63
FR64
FR65
FR66
FR67
FR68
FR69
FR70
FR71
FR72
FR73
FR74
FR75
FR76
FR77
FR78
FR79
FR80
FR81
FR82
FR83
FR84
FR85
FR86
FR87
FR88
FR89
FR90
FR91
FR92
FR93
FR94
FR95
FR96
FR97
FR98
FR99
FR100
FR101
FR102
FR103
FR104
FR105
FR106
FR107
FR108
FR109
FR110
FR111
FR112
FR113
FR114
FR115
FR116
FR117
FR118
FR119
FR120
FR121
FR122
FR123
FR124
FR125
FR126
FR127
FR128
FR129
FR130
FR131
FR132
FR133
FR134
FR135
FR136
FR137
FR138
FR139
FR140
FR141
FR142
FR143
FR144
FR145
FR146
FR147
FR148
FR149
FR150
FR151
FR152
FR153
FR154
FR155
FR156
FR157
FR158
FR159
FR160
FR161
FR162
FR163
FR164
FR165
FR166
FR167
FR168
FR169
FR170
FR171
FR172
FR173
FR174
FR175
FR176
FR177
FR178
FR179
FR180
FR181
FR182
FR183
FR184
FR185
FR186
FR187
FR188
FR189
FR190
FR191
FR192
FR193
FR194
FR195
FR196
FR197
FR198
FR199
FR200
FR201
FR202
FR203
FR204
FR205
FR206
FR207
FR208
FR209
FR210
FR211
FR212
FR213
FR214
FR215
FR216
FR217
FR218
FR219
FR220
FR221
FR222
FR223
FR224
FR225
FR226
FR227
FR228
FR229
FR230
FR231
FR232
FR233
FR234
FR235
FR236
FR237
FR238
FR239
FR240
FR241
FR242
FR243
FR244
FR245
FR246
FR247
FR248
FR249
FR250
FR251
FR252
FR253
FR254
FR255
FR256
FR257
FR258
FR259
FR260
FR261
FR262
FR263
FR264
FR265
FR266
FR267
FR268
FR269
FR270
FR271
FR272
FR273
FR274
FR275
FR276
FR277
FR278
FR279
FR280
FR281
FR282
FR283
FR284
FR285
FR286
FR287
FR288
FR289
FR290
FR291
FR292
FR293
FR294
FR295
FR296
FR297
FR298
FR299
FR300
FR301
FR302
FR303
FR304
FR305
FR306
FR307
FR308
FR309
FR310
FR311
FR312
FR313
FR314
FR315
FR316
FR317
FR318
FR319
FR320
FR321
FR322
FR323
FR324
FR325
FR326
FR327
FR328
FR329
FR330
FR331
FR332
FR333
FR334
FR335
FR336
FR337
FR338
FR339
FR340
FR341
FR342
FR343
FR344
FR345
FR346
FR347
FR348
FR349
FR350
FR351
FR352
FR353
FR354
FR355
FR356
FR357
FR358
FR359
FR360
FR361
FR362
FR363
FR364
FR365
FR366
FR367
FR368
FR369
FR370
FR371
FR372
FR373
FR374
FR375
FR376
FR377
FR378
FR379
FR380
FR381
FR382
FR383
FR384
FR385
FR386
FR387
FR388
FR389
FR390
FR391
FR392
FR393
FR394
FR395
FR396
FR397
FR398
FR399
FR400
FR401
FR402
FR403
FR404
FR405
FR406
FR407
FR408
FR409
FR410
FR411
FR412
FR413
FR414
FR415
FR416
FR417
FR418
FR419
FR420
FR421
FR422
FR423
FR424
FR425
FR426
FR427
FR428
FR429
FR430
FR431
FR432
FR433
FR434
FR435
FR436
FR437
FR438
FR439
FR440
FR441
FR442
FR443
FR444
FR445
FR446
FR447
FR448
FR449
FR450
FR451
FR452
FR453
FR454
FR455
FR456
FR457
FR458
FR459
FR460
FR461
FR462
FR463
FR464
FR465
FR466
FR467
FR468
FR469
FR470
FR471
FR472
FR473
FR474
FR475
FR476
FR477
FR478
FR479
FR480
FR481
FR482
FR483
FR484
FR485
FR486
FR487
FR488
FR489
FR490
FR491
FR492
FR493
FR494
FR495
FR496
FR497
FR498
FR499
FR500
FR501
FR502
FR503
FR504
FR505
FR506
FR507
FR508
FR509
FR510
FR511
FR512
FR513
FR514
FR515
FR516
FR517
FR518
FR519
FR520
FR521
FR522
FR523
FR524
FR525
FR526
FR527
FR528
FR529
FR530
FR531
FR532
FR533
FR534
FR535
FR536
FR537
FR538
FR539
FR540
FR541
FR542
FR543
FR544
FR545
FR546
FR547
FR548
FR549
FR550
FR551
FR552
FR553
FR554
FR555
FR556
FR557
FR558
FR559
FR560
FR561
FR562
FR563
FR564
FR565
FR566
FR567
FR568
FR569
FR570
FR571
FR572
FR573
FR574
FR575
FR576
FR577
FR578
FR579
FR580
FR581
FR582
FR583
FR584
FR585
FR586
FR587
FR588
FR589
FR590
FR591
FR592
FR593
FR594
FR595
FR596
FR597
FR598
FR599
FR600
FR601
FR602
FR603
FR604
FR605
FR606
FR607
FR608
FR609
FR610
FR611
FR612
FR613
FR614
FR615
FR616
FR617
FR618
FR619
FR620
FR621
FR622
FR623
FR624
FR625
FR626
FR627
FR628
FR629
FR630
FR631
FR632
FR633
FR634
FR635
FR636
FR637
FR638
FR639
FR640
FR641
FR642
FR643
FR644
FR645
FR646
FR647
FR648
FR649
FR650
FR651
FR652
FR653
FR654
FR655
FR656
FR657
FR658
FR659
FR660
FR661
FR662
FR663
FR664
FR665
FR666
FR667
FR668
FR669
FR670
FR671
FR672
FR673
FR674
FR675
FR676
FR677
FR678
FR679
FR680
FR681
FR682
FR683
FR684
FR685
FR686
FR687
FR688
FR689
FR690
FR691
FR692
FR693
FR694
FR695
FR696
FR697
FR698
FR699
FR700
FR701
FR702
FR703
FR704
FR705
FR706
FR707
FR708
FR709
FR710
FR711
FR712
FR713
FR714
FR715
FR716
FR717
FR718
FR719
FR720
FR721
FR722
FR723
FR724
FR725
FR726
FR727
FR728
FR729
FR730
FR731
FR732
FR733
FR734
FR735
FR736
FR737
FR738
FR739
FR740
FR741
FR742
FR743
FR744
FR745
FR746
FR747
FR748
FR749
FR750
FR751
FR752
FR753
FR754
FR755
FR756
FR757
FR758
FR759
FR760
FR761
FR762
FR763
FR764
FR765
FR766
FR767
FR768
FR769
FR770
FR771
FR772
FR773
FR774
FR775
FR776
FR777
FR778
FR779
FR780
FR781
FR782
FR783
FR784
FR785
FR786
FR787
FR788
FR789
FR790
FR791
FR792
FR793
FR794
FR795
FR796
FR797
FR798
FR799
FR800
FR801
FR802
FR803
FR

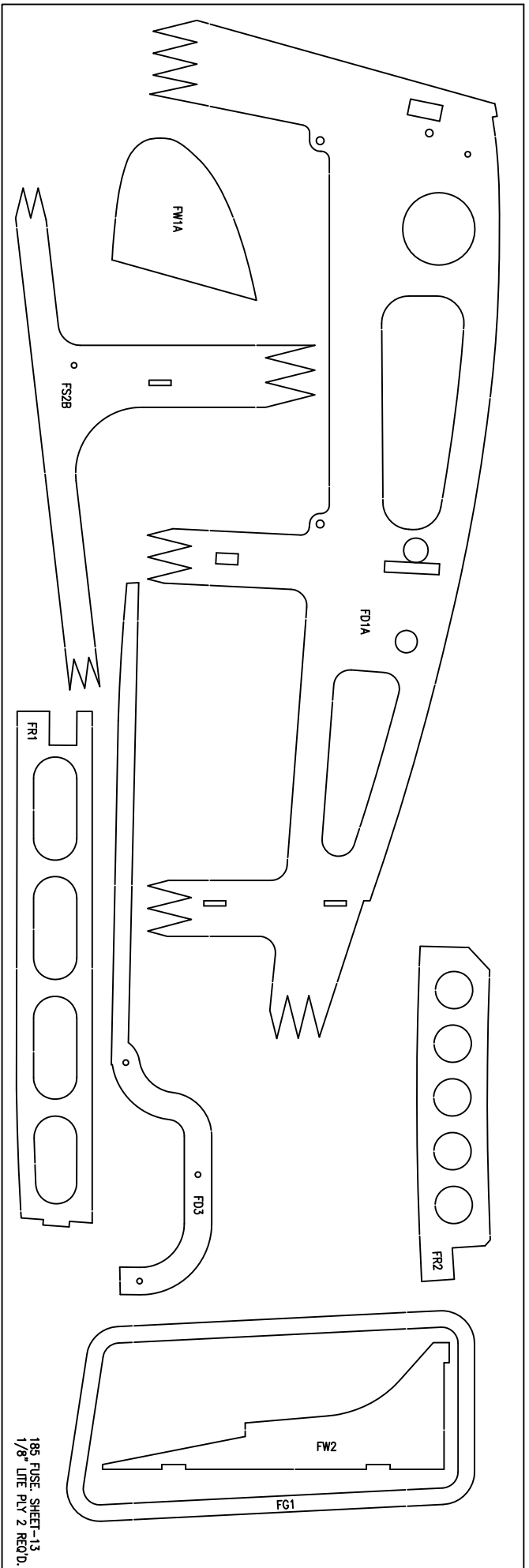

12" WIDE x 36" LONG x 1/8" THICK LITE PLY TWO (2) REQUIRED

185 FUSE. SHEET-13
1/8" LITE PLY 2 REQ'D.

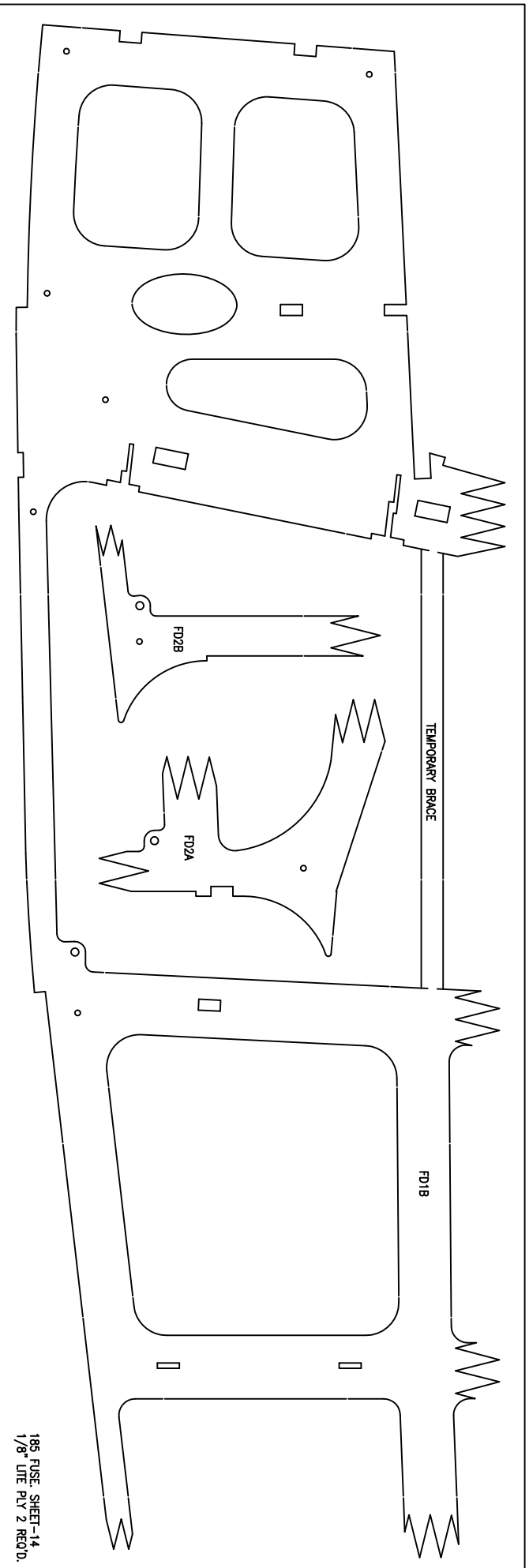

12" WIDE x 36" LONG x 1/8" THICK LITE PLY TWO (2) REQUIRED

185 FUSE. SHEET-14
1/8" LITE PLY 2 REQ'D.

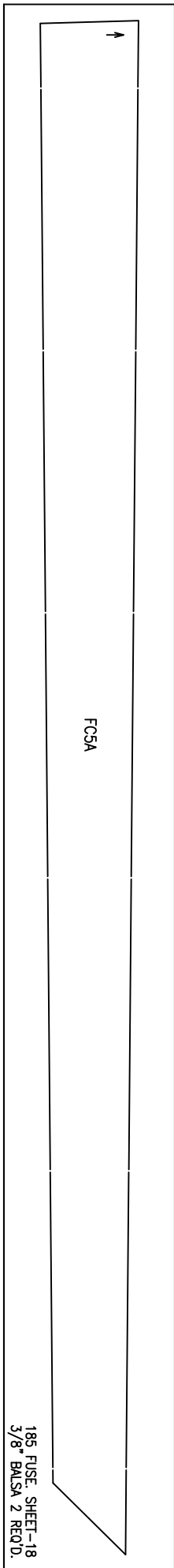
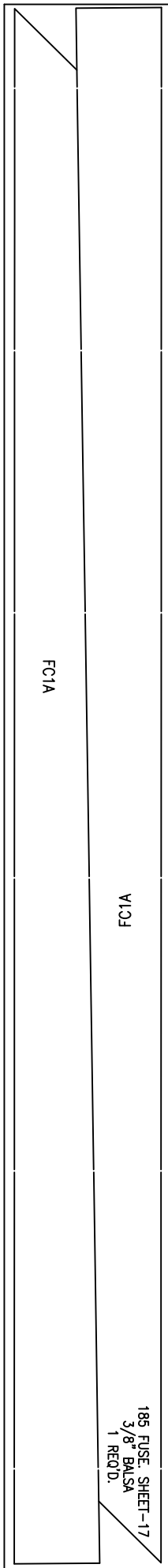
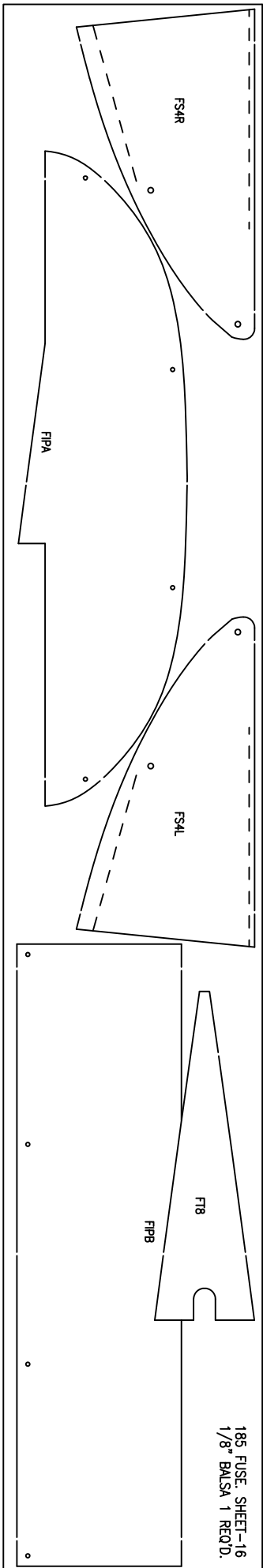
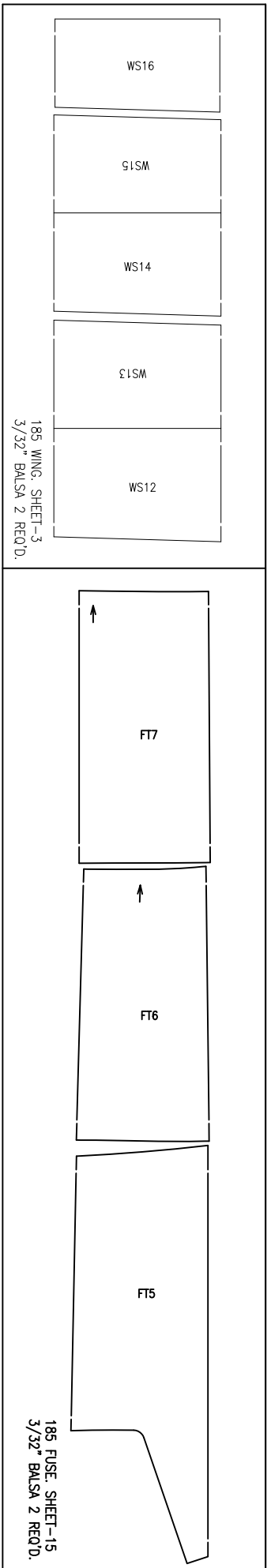

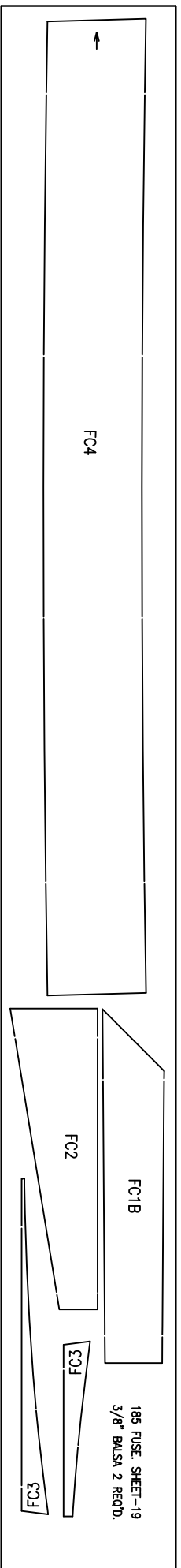

4" WIDE x 36" LONG x 3/8" THICK Balsa TWO (2) REQUIRED

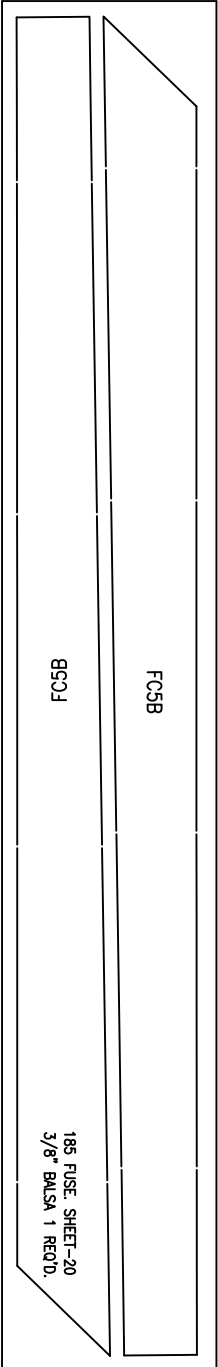

4" WIDE x 36" LONG x 3/8" THICK Balsa ONE (1) REQUIRED

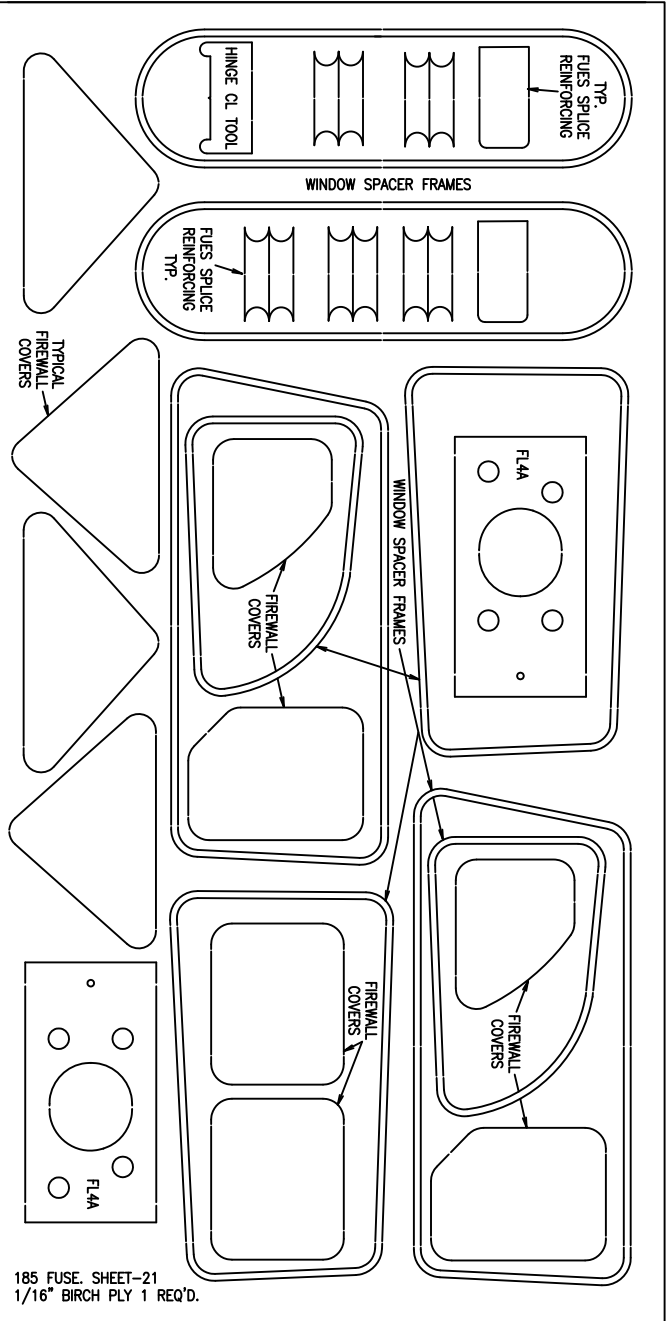

12" WIDE x 24" LONG x 1/16" THICK BIRCH PLY ONE (1) REQUIRED

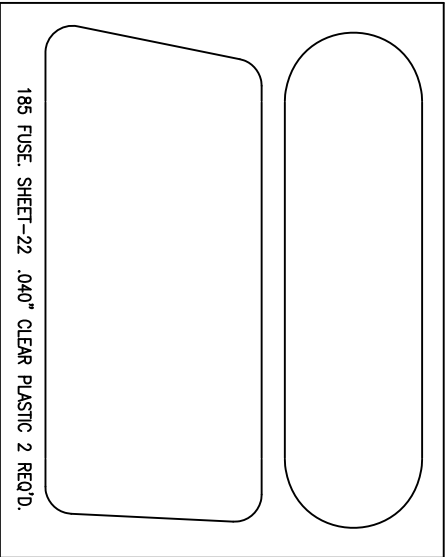

8" WIDE x 10" LONG x .040" THICK CLEAR PLATIC TWO (2) REQUIRED

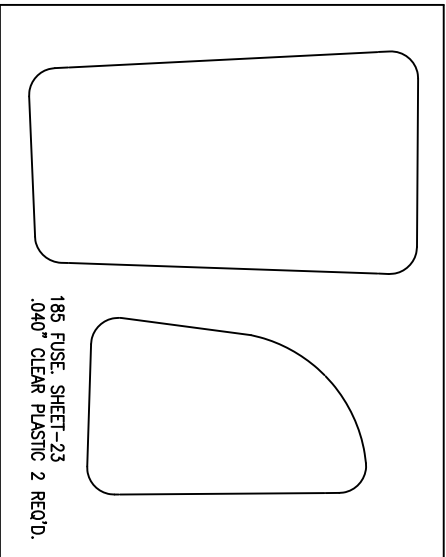

8" WIDE x 10" LONG x .040" THICK CLEAR PLATIC TWO (2) REQUIRED

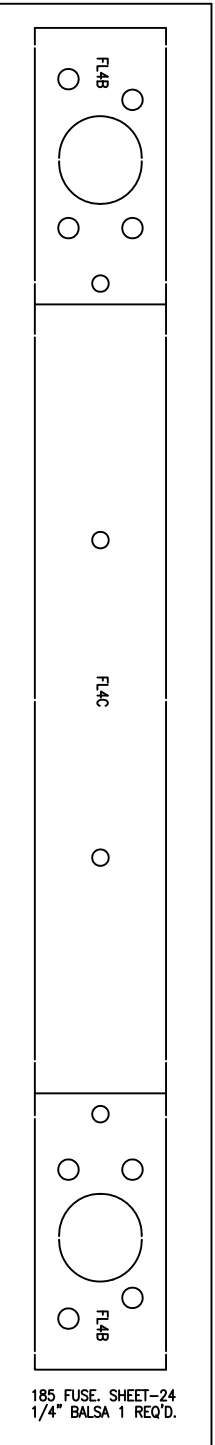

4" WIDE x 26" LONG x 1/4" THICK BALSA ONE (1) REQUIRED

185 FUSE SHEET-24
1/4" BALSA 1 REQ'D.

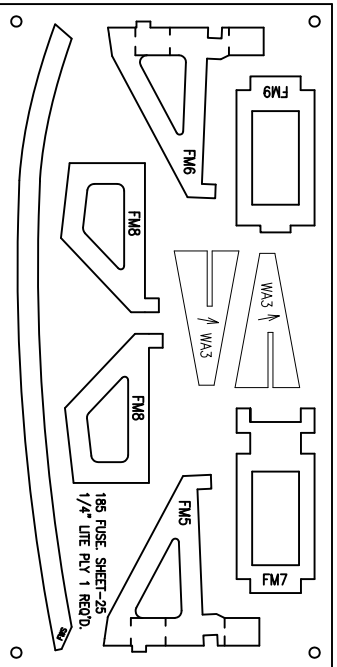

6" WIDE x 12" LONG x 1/4" THICK LITE PLY ONE (1) REQUIRED

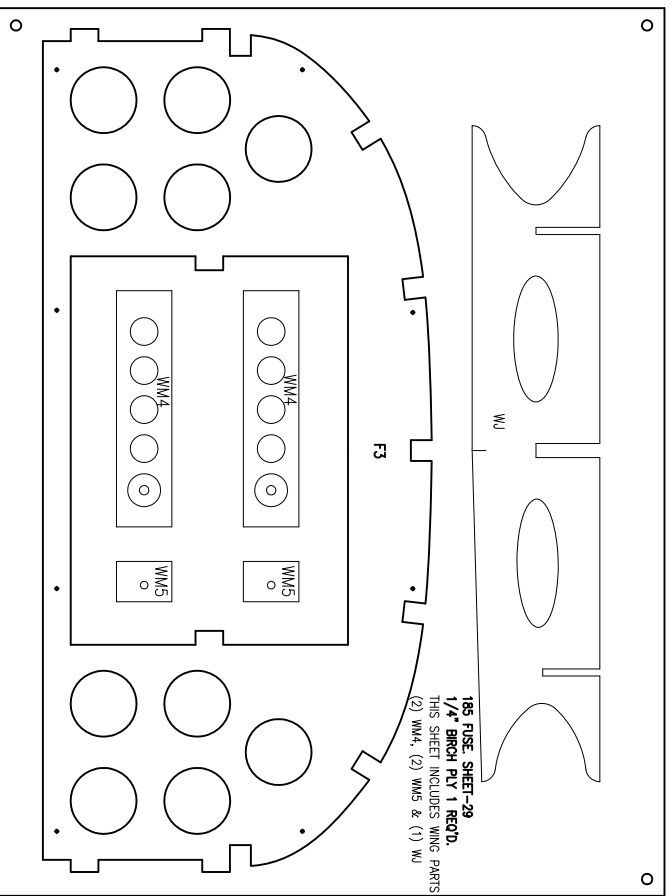
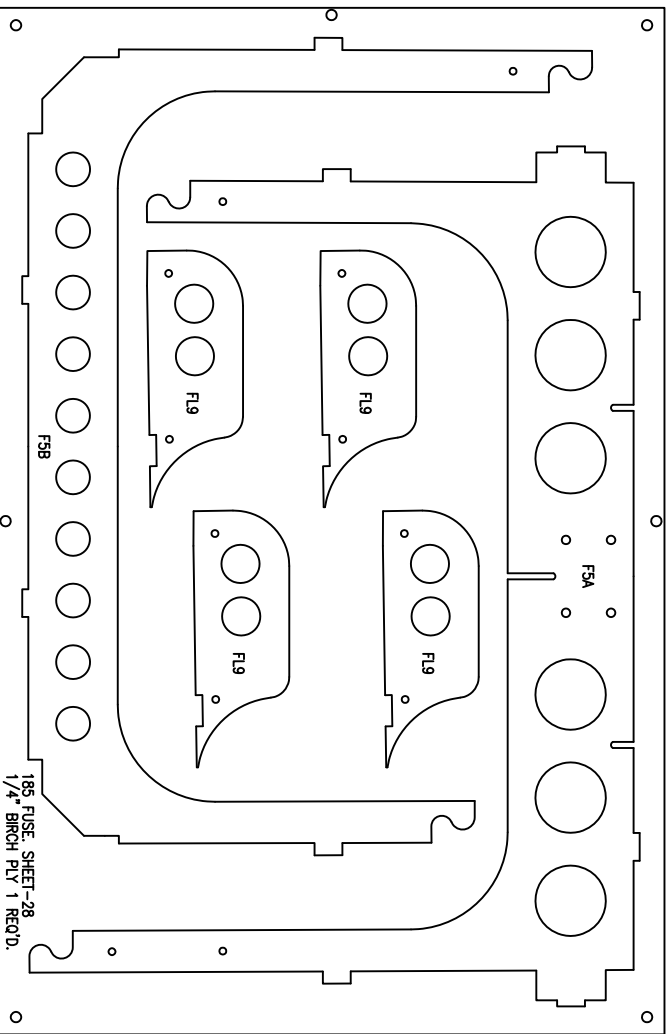
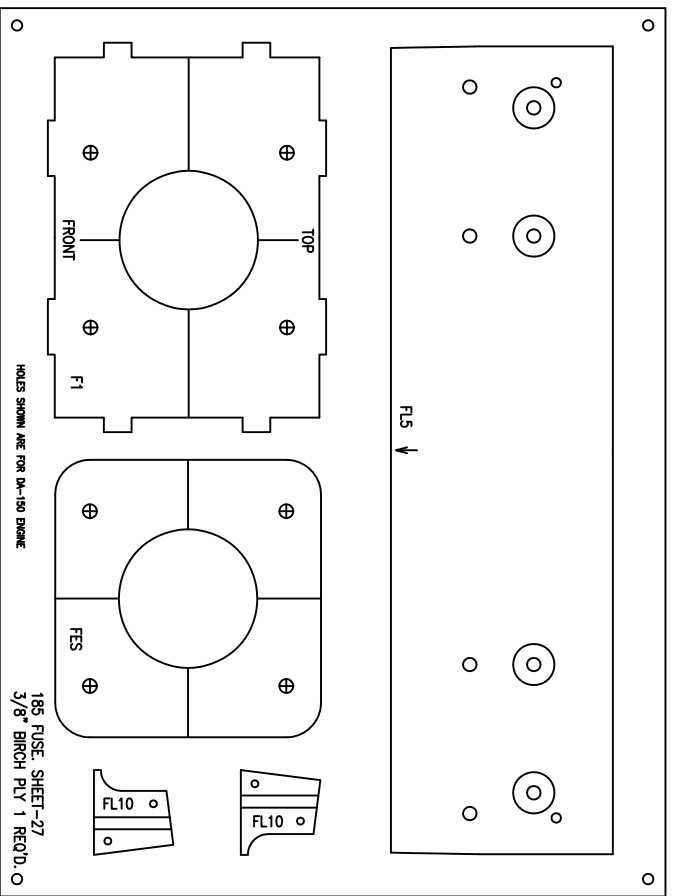
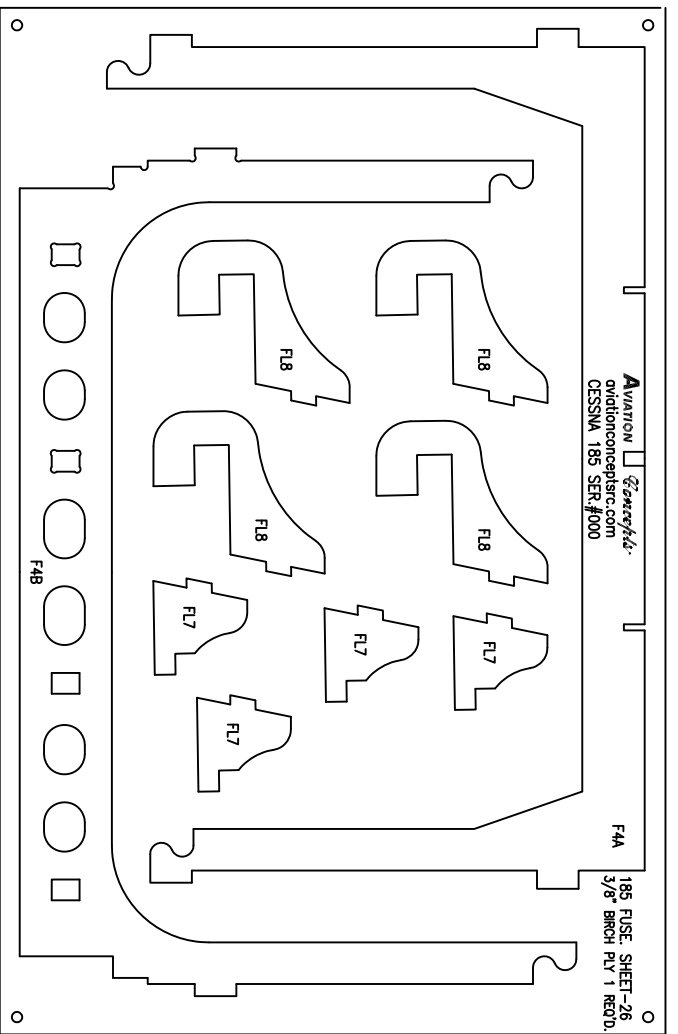

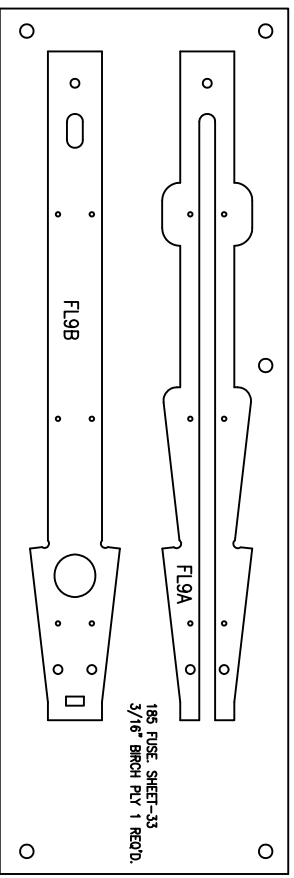
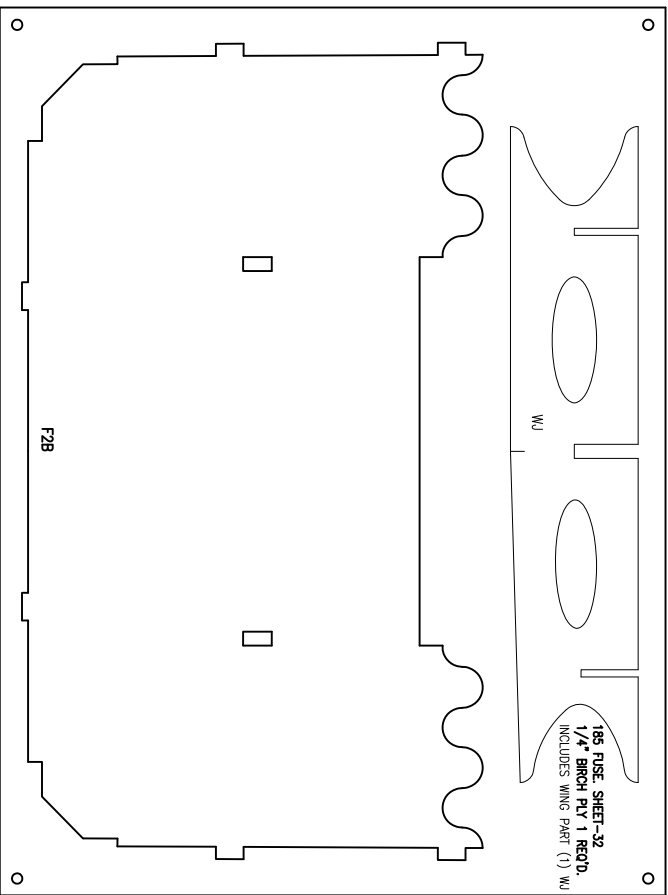
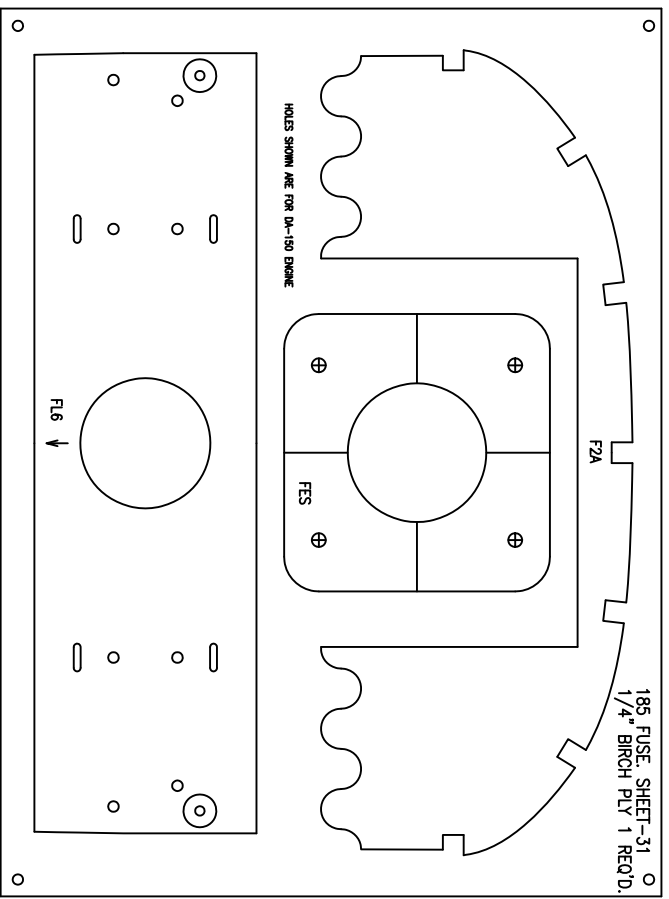
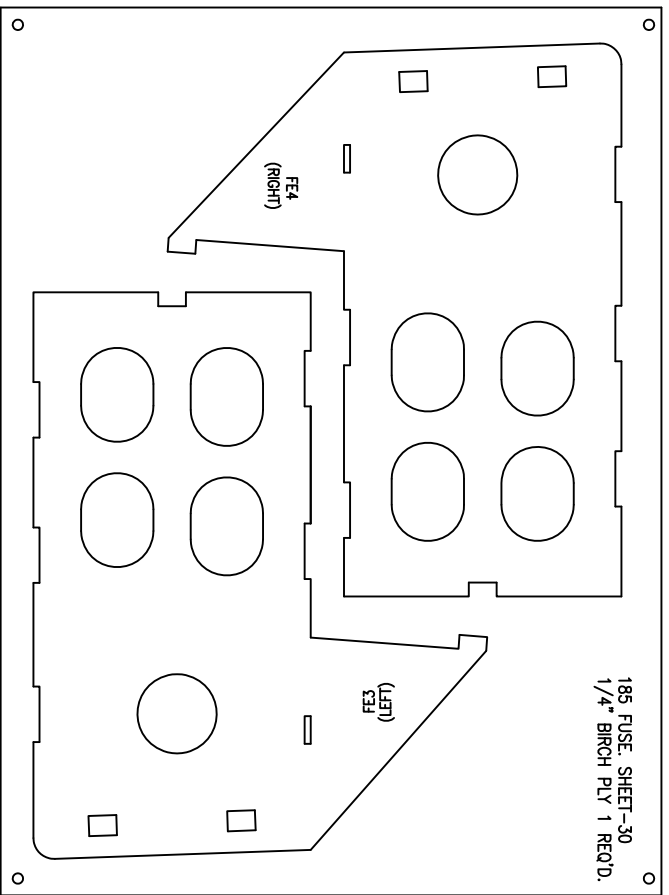

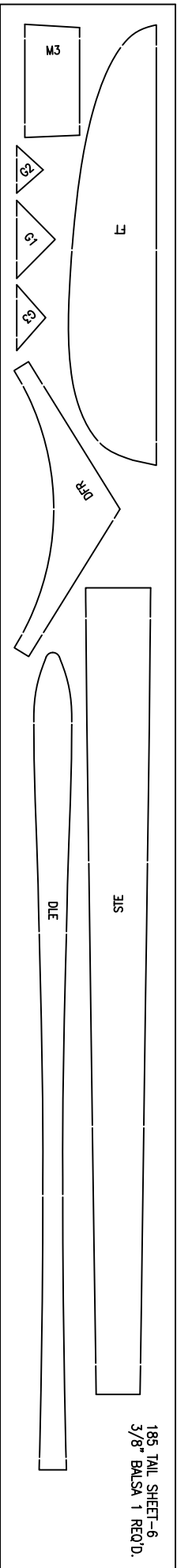
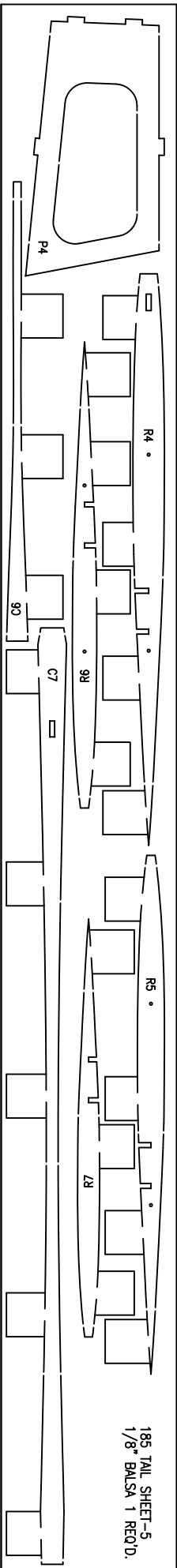
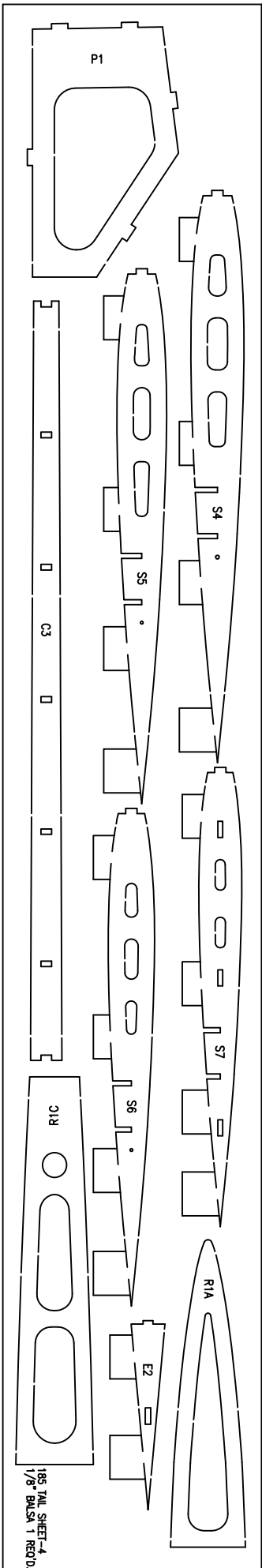
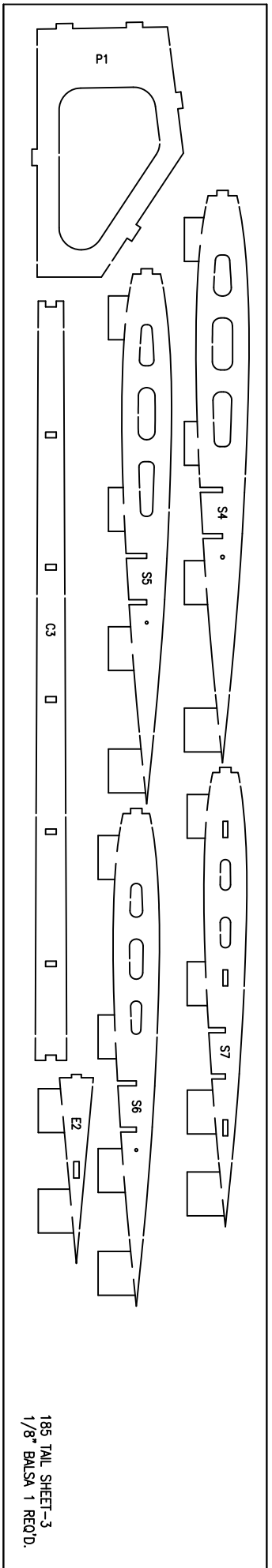

4" WIDE x 36" LONG x 3/8" THICK Balsa ONE (1) REQUIRED

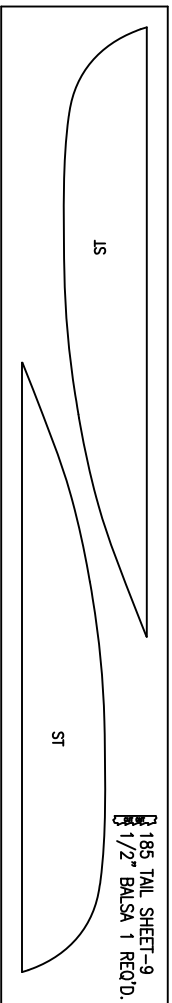
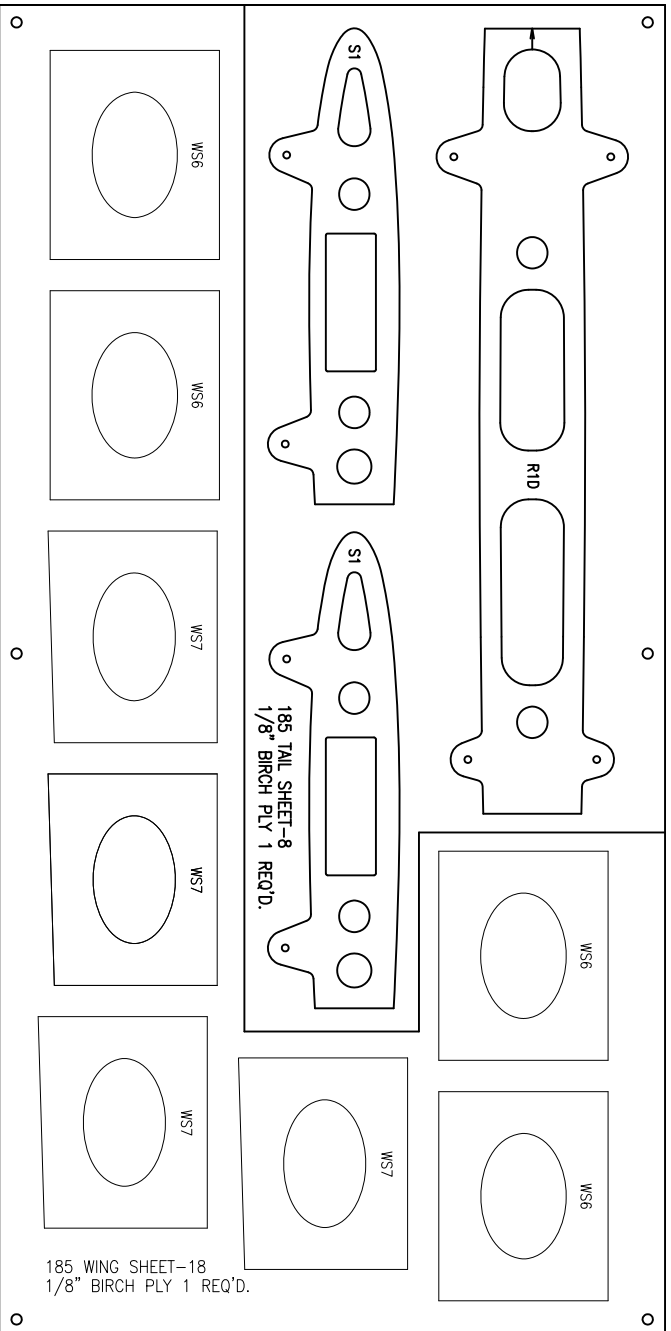
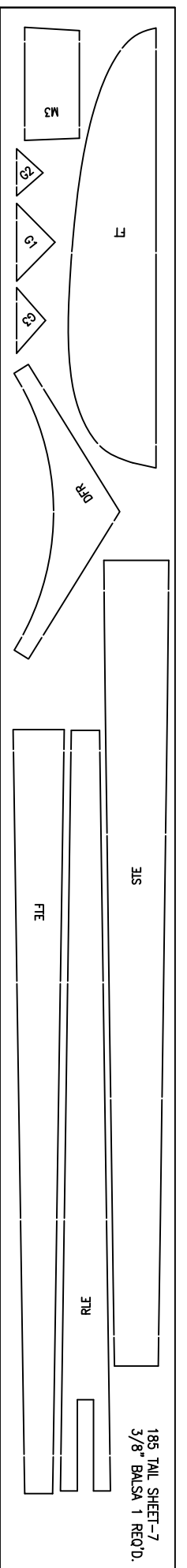

3" WIDE x 18" LONG x 1/2" THICK BALSAM ONE (1) REQUIRED

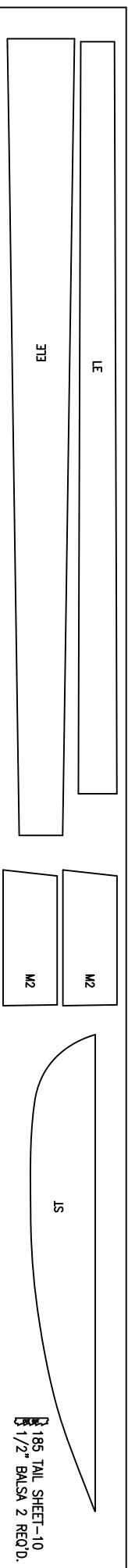

3" WIDE x 36" LONG x 1/2" THICK BALSAM TWO (2) REQUIRED

185 TAIL PARTS SHEET-15

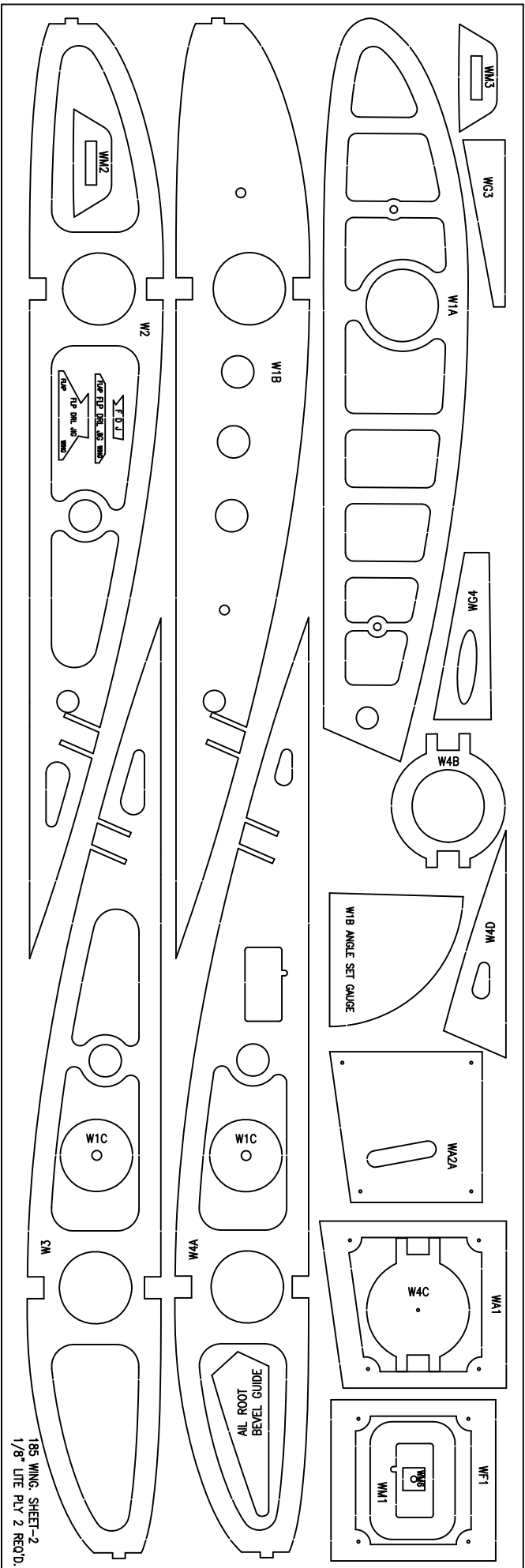
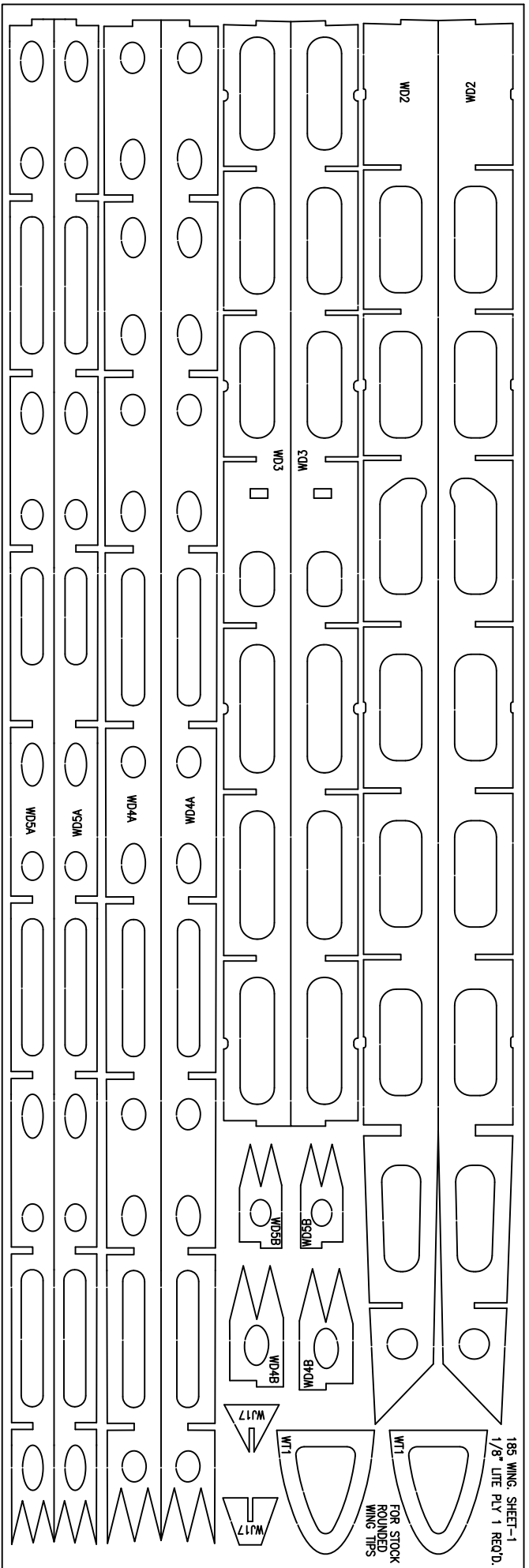

12" WIDE x 36" LONG x 1/8" THICK LITE PLY TWO (2) REQUIRED

185 WING PARTS SHEET-16

185 WING SHEET-1
1/8" LITE PLY 1 REQ'D.

185 WING SHEET-2
1/8" LITE PLY 2 REQ'D.

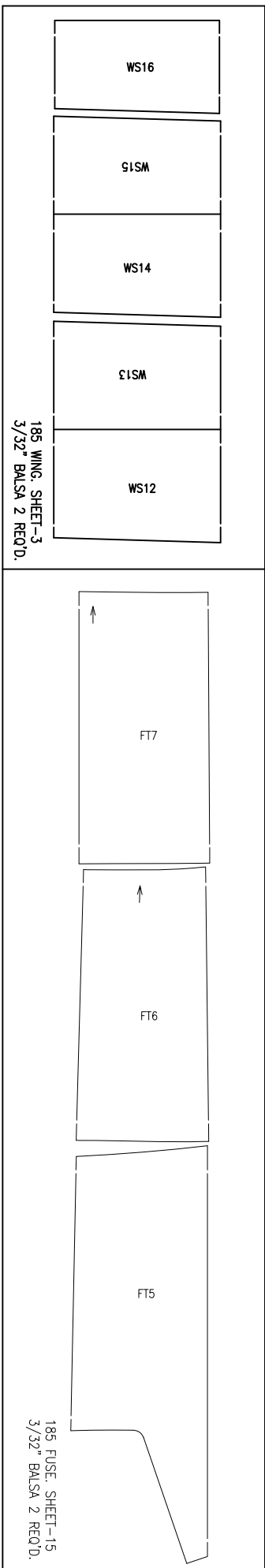

6" WIDE x 36" LONG x 3/32" THICK Balsa TWO (2) REQUIRED

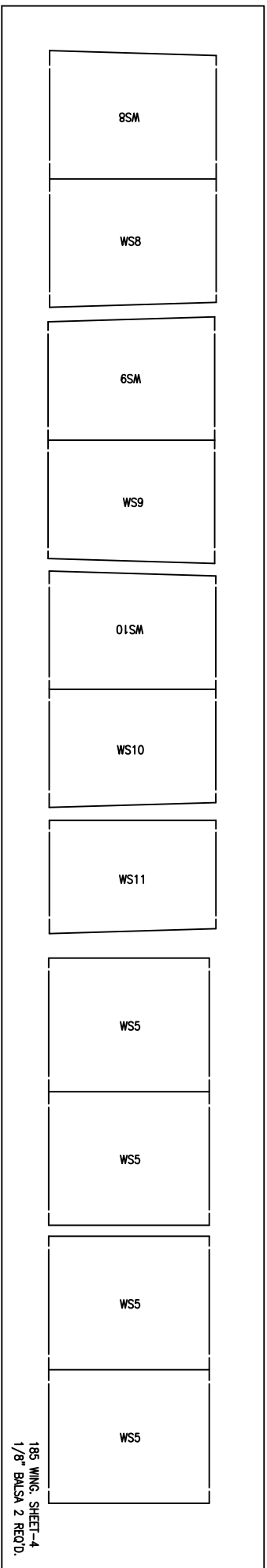

6" WIDE x 36" LONG x 1/8" THICK Balsa TWO (2) REQUIRED

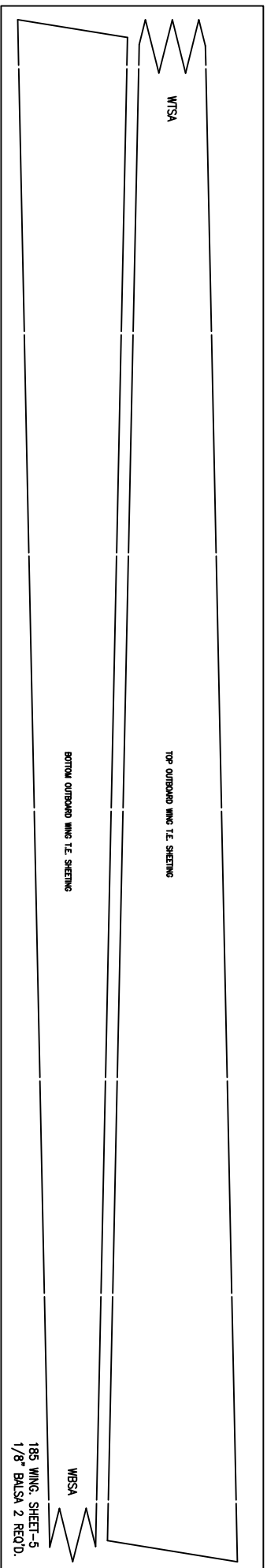

6" WIDE x 36" LONG x 1/8" THICK Balsa TWO (2) REQUIRED

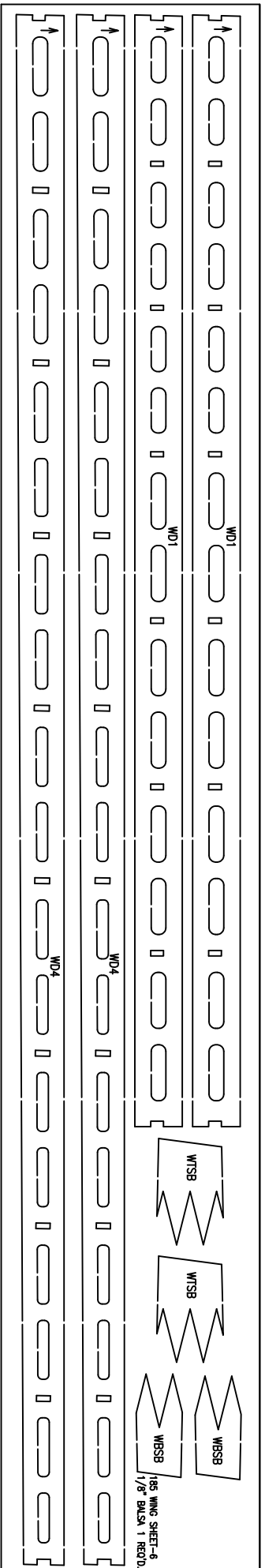

6" WIDE x 36" LONG x 1/8" THICK Balsa ONE (1) REQUIRED

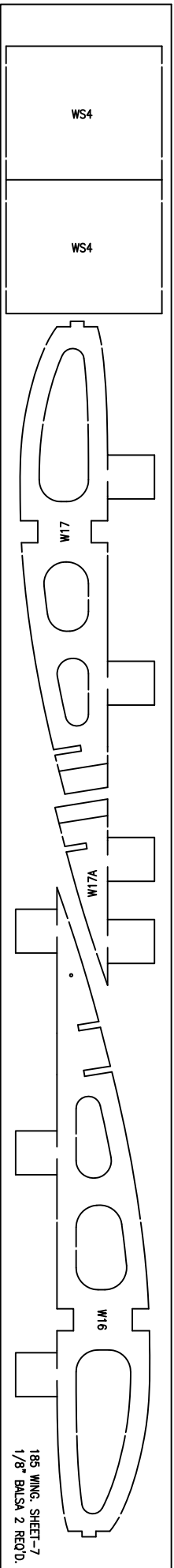

4" WIDE x 36" LONG x 1/8" THICK Balsa TWO (2) REQUIRED

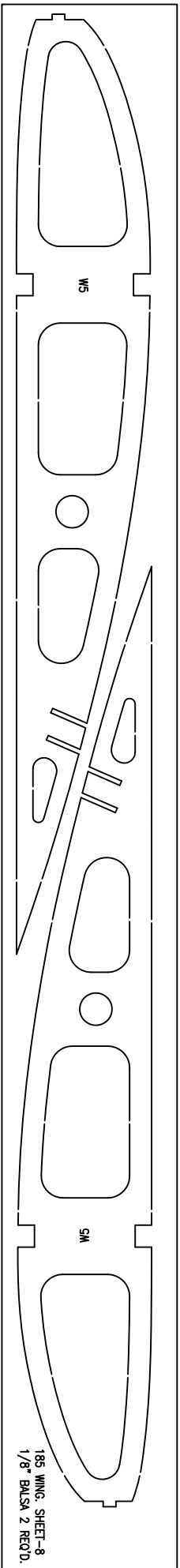

4" WIDE x 36" LONG x 1/8" THICK Balsa TWO (2) REQUIRED

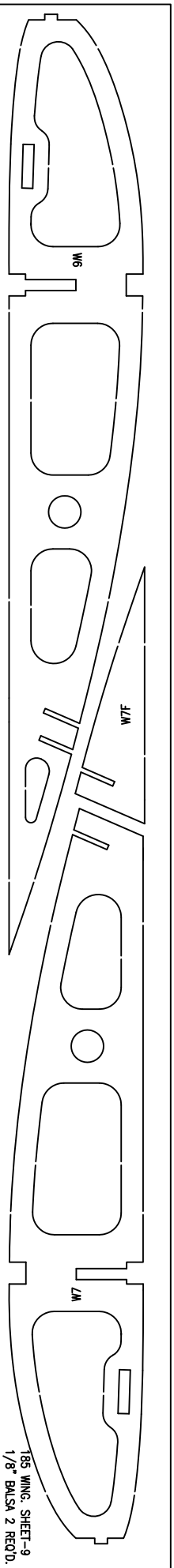

4" WIDE x 36" LONG x 1/8" THICK Balsa TWO (2) REQUIRED

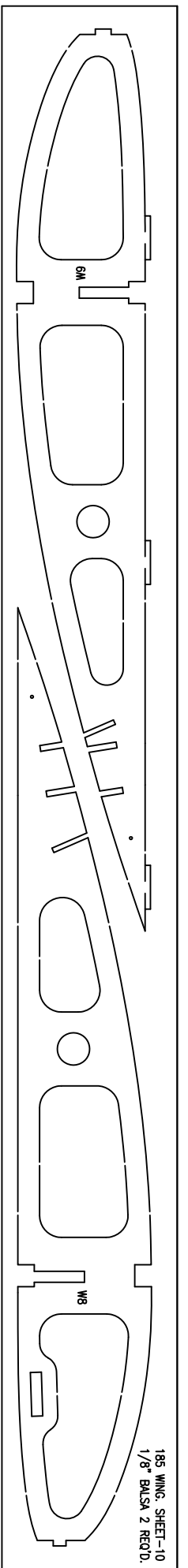

4" WIDE x 36" LONG x 1/8" THICK Balsa TWO (2) REQUIRED

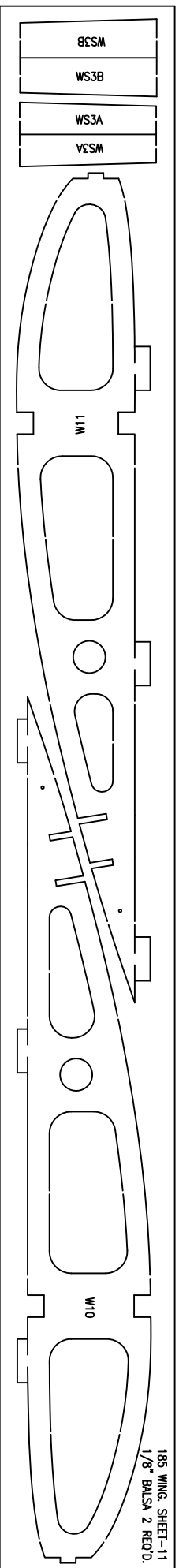

4" WIDE x 36" LONG x 1/8" THICK Balsa TWO (2) REQUIRED

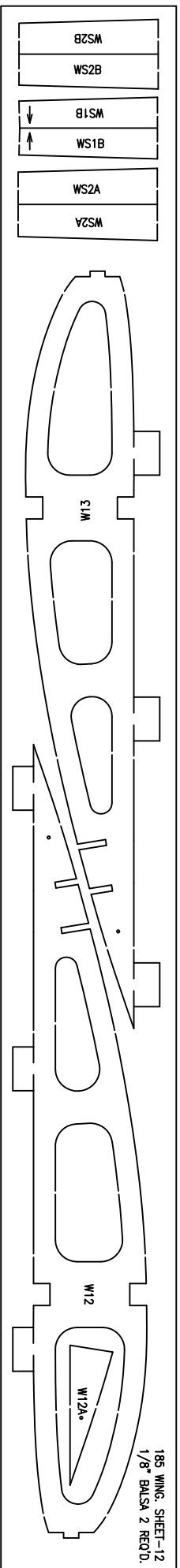

4" WIDE x 36" LONG x 1/8" THICK Balsa TWO (2) REQUIRED

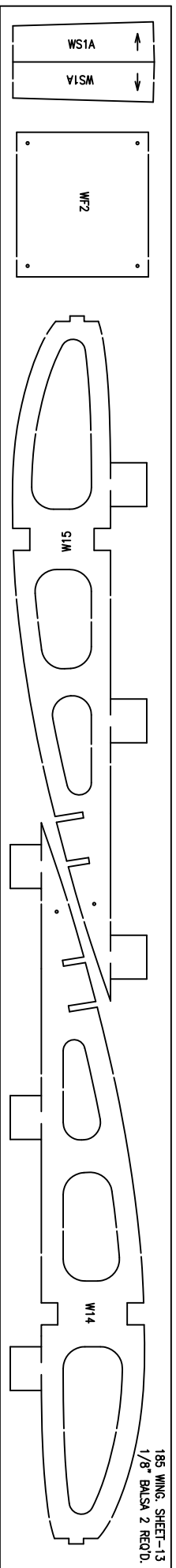

4" WIDE x 36" LONG x 1/8" THICK Balsa TWO (2) REQUIRED

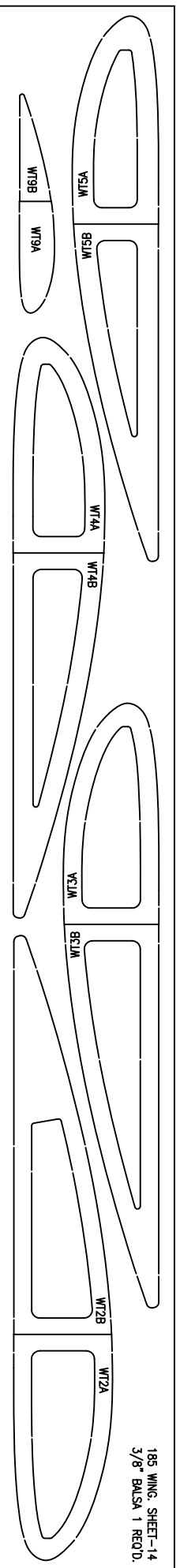

4" WIDE x 36" LONG x 3/8" THICK Balsa ONE (1) REQUIRED FOR STOCK ROUNDED WING TIPS IF ORDERED

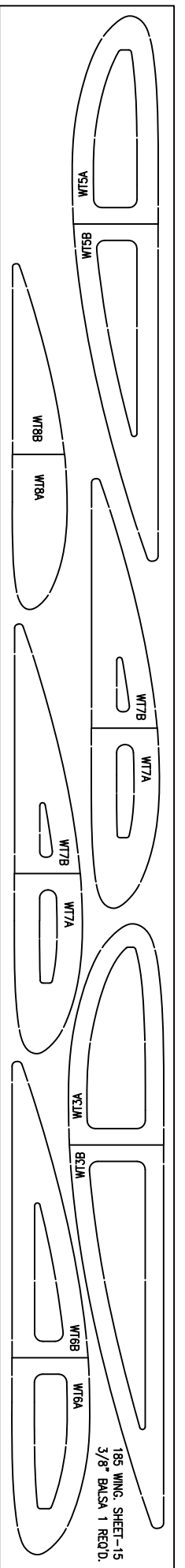

4" WIDE x 36" LONG x 3/8" THICK BALSAM ONE (1) REQUIRED
FOR STOCK ROUNDED WING TIPS IF ORDERED

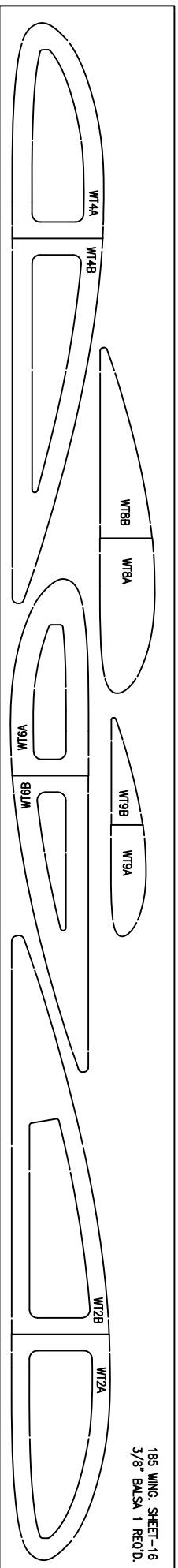

4" WIDE x 36" LONG x 3/8" THICK BALSAM ONE (1) REQUIRED
FOR STOCK ROUNDED WING TIPS IF ORDERED

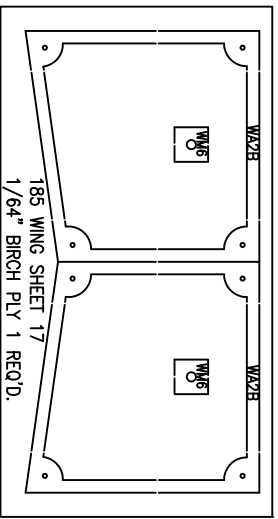

4" WIDE x 7 1/2" LG. x 1/64" THK. BIRCH PLY ONE (1) REQ'D.

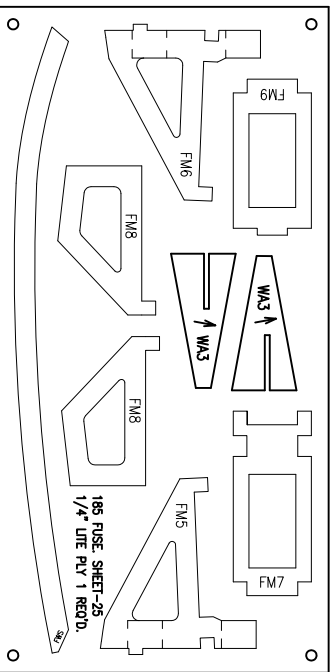

6" WIDE x 12" LONG x 1/4" THICK LITE PLY ONE (1) REQUIRED

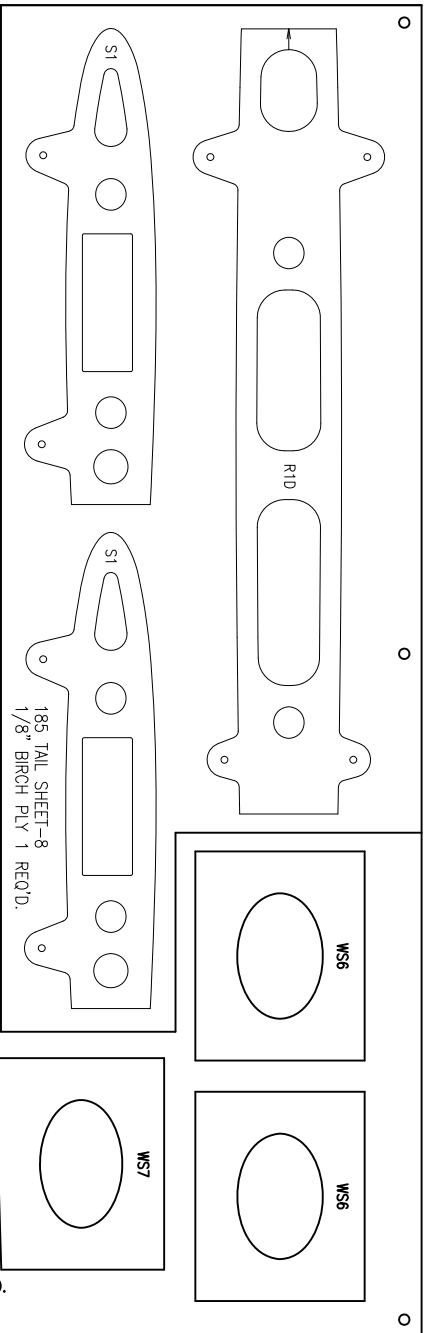

185 TAIL, SHEET-8
1/8" BIRCH PLY 1 REQ'D.

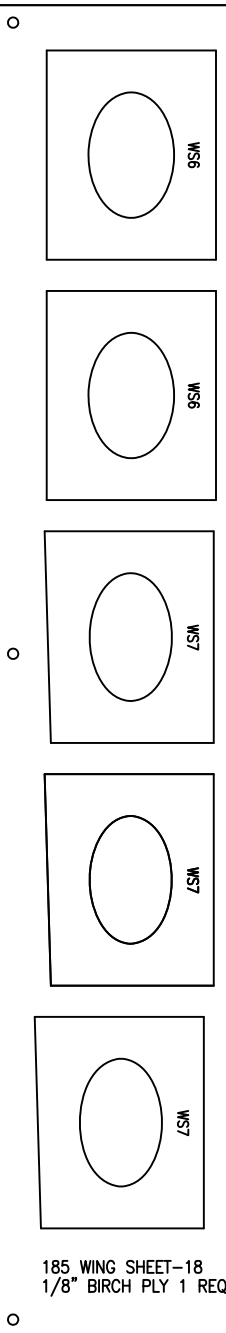

12" WIDE x 24" LONG x 1/8" THICK BIRCH PLY ONE (1) REQUIRED

185 WING PARTS, SHEET-20

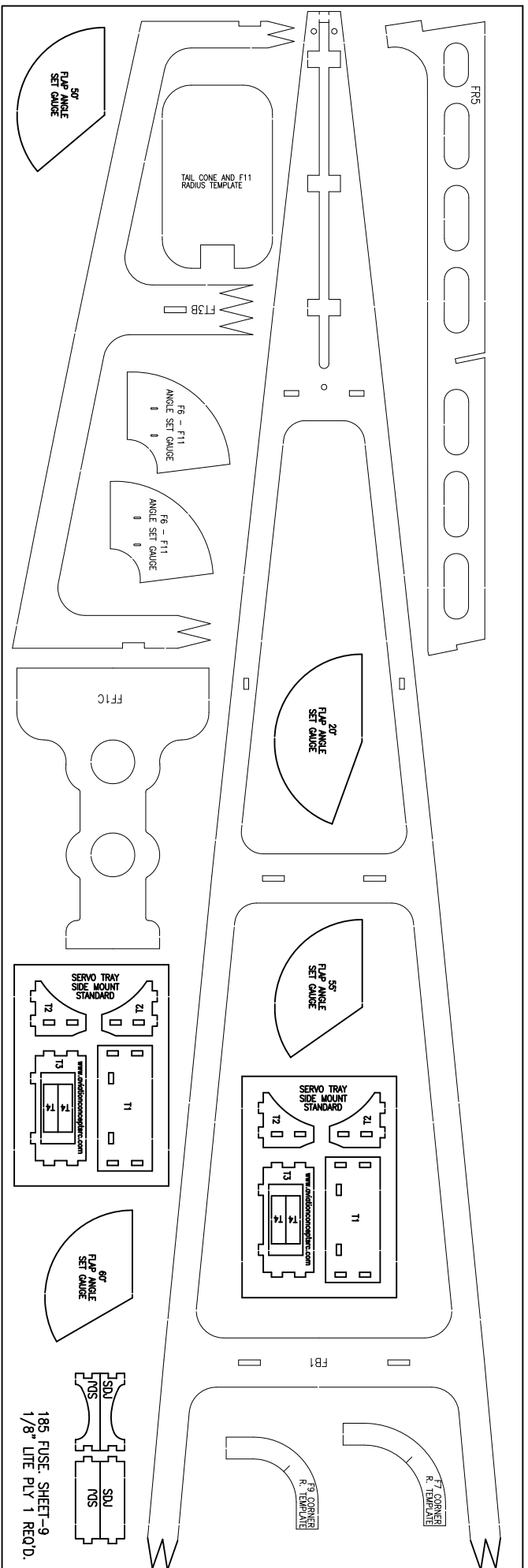

12" WIDE x 36" LONG x 1/8" THICK LITE PLY ONE (1) REQUIRED

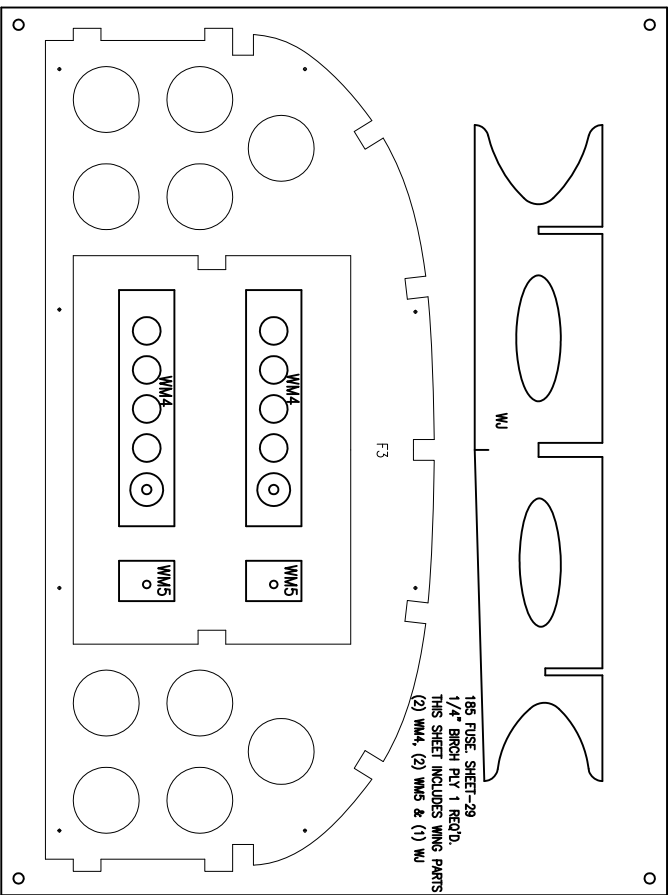

12" WIDE x 16" LONG x 1/4" THICK BIRCH PLY ONE (1) REQUIRED

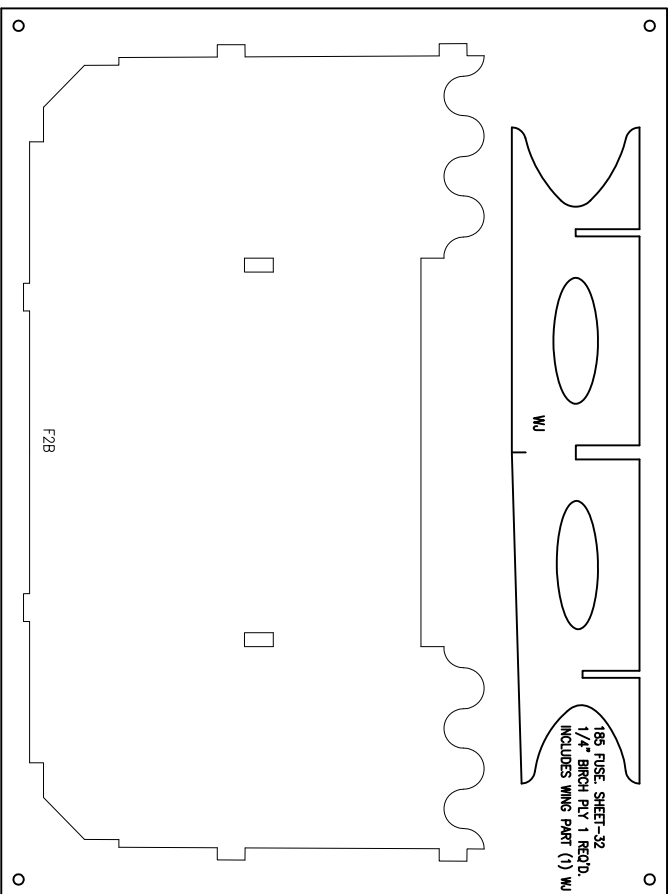

12" WIDE x 16" LONG x 1/4" THICK BIRCH PLY ONE (1) REQUIRED

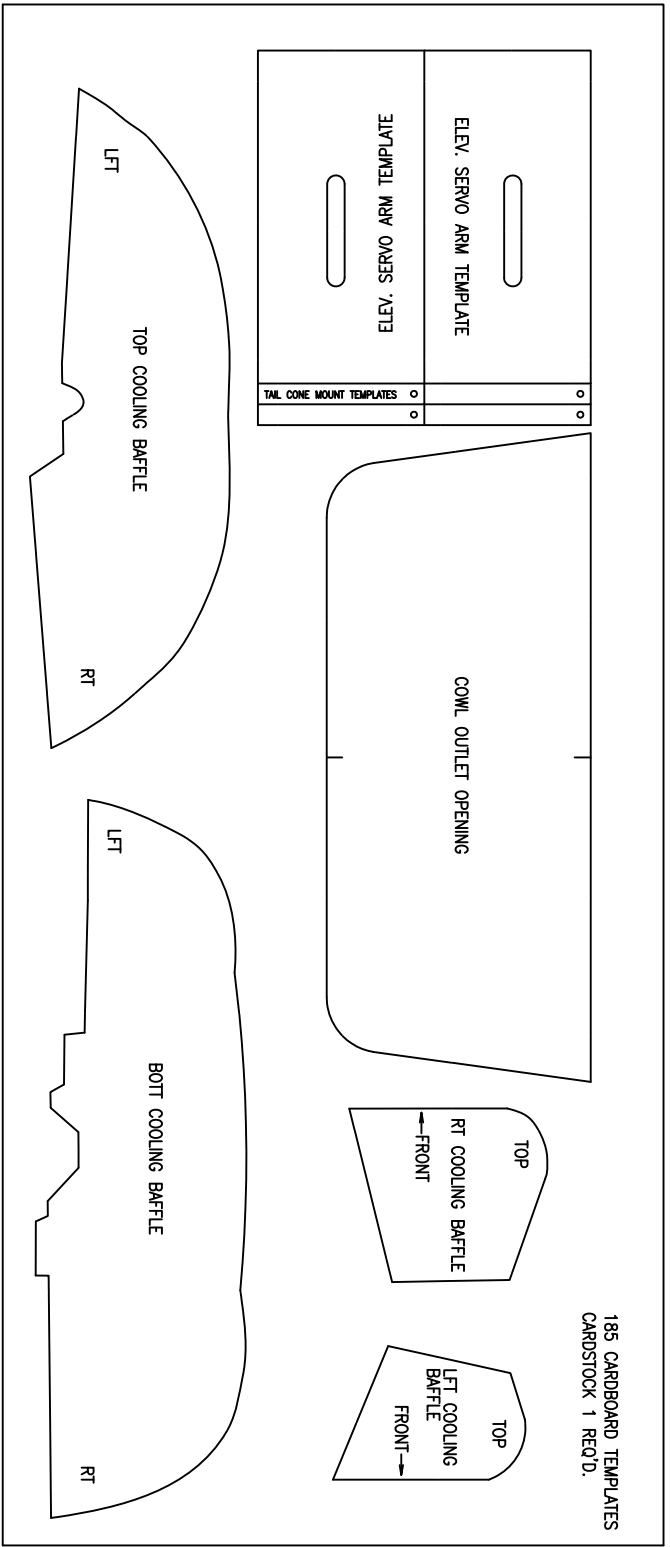

11" WIDE x 28" LONG CARDSTOCK ONE (1) REQUIRED

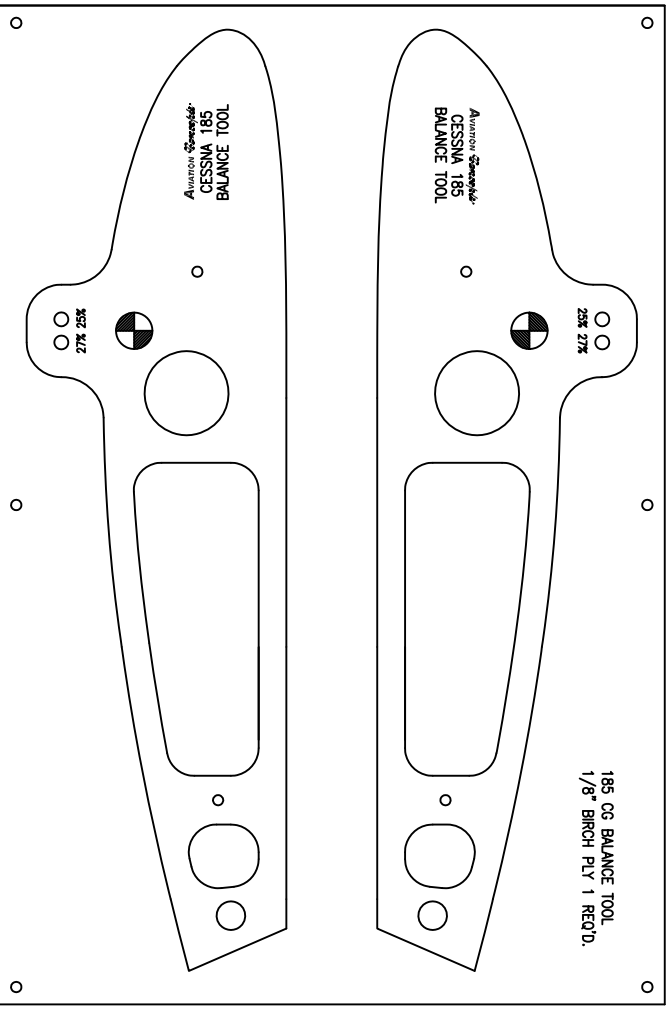

12" WIDE x 18" LONG x 1/8" THICK BIRCH PLY ONE (1) REQUIRED

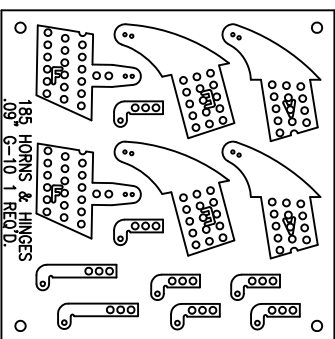
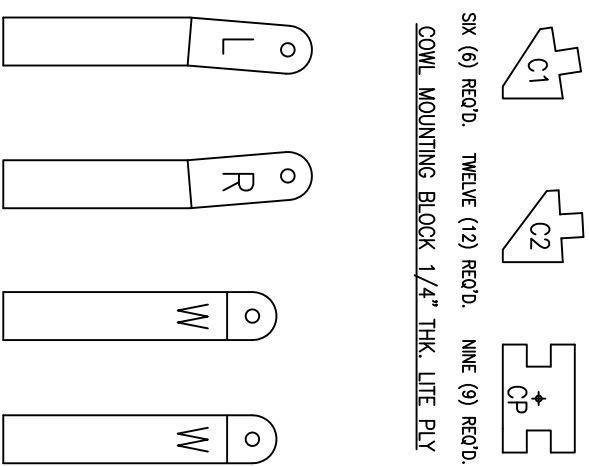

6" x 6" x 3/32" THK. G-10 ONE (1) REQUIRED

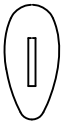

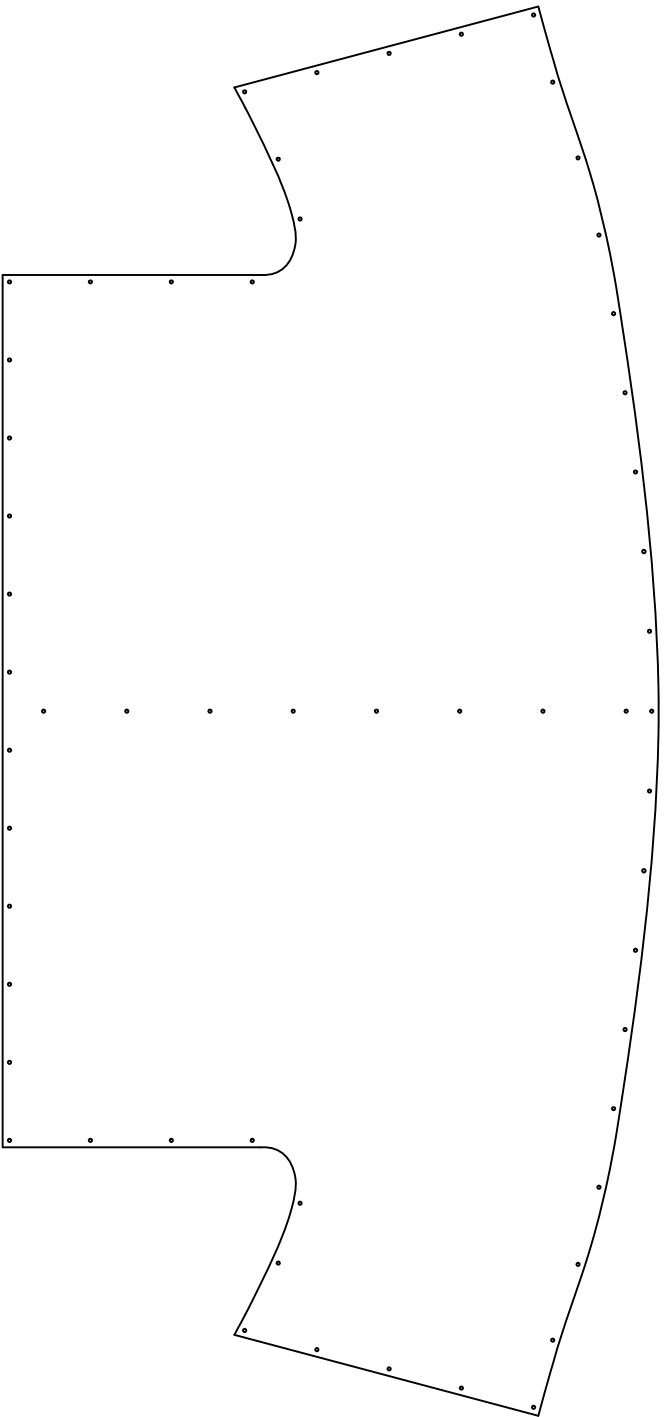
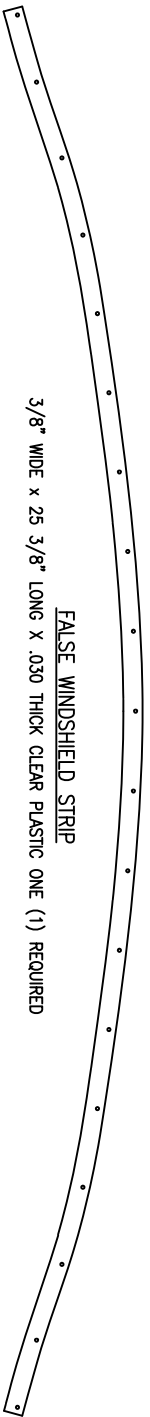
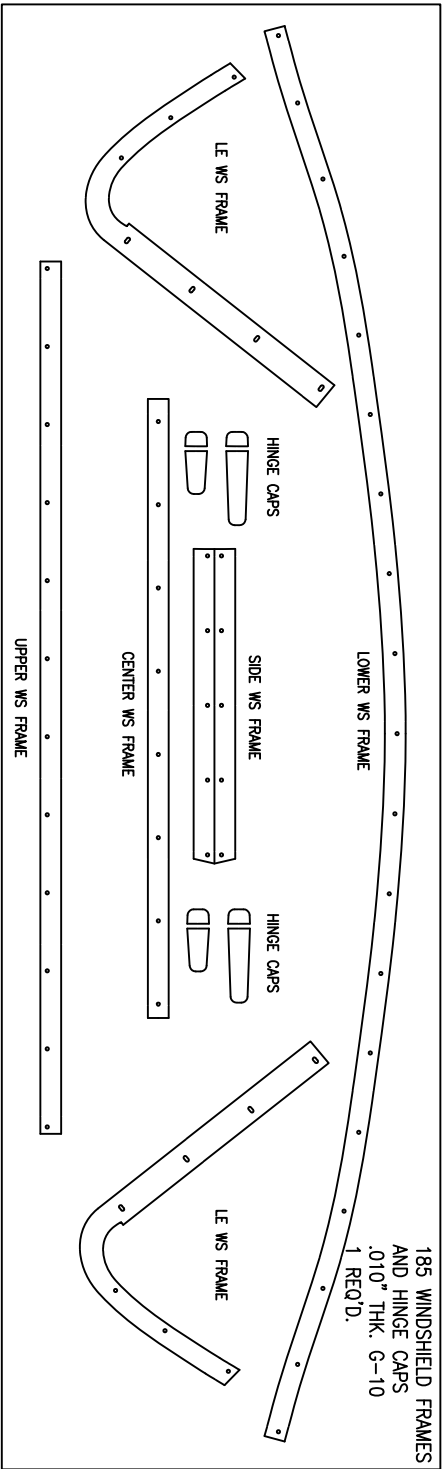

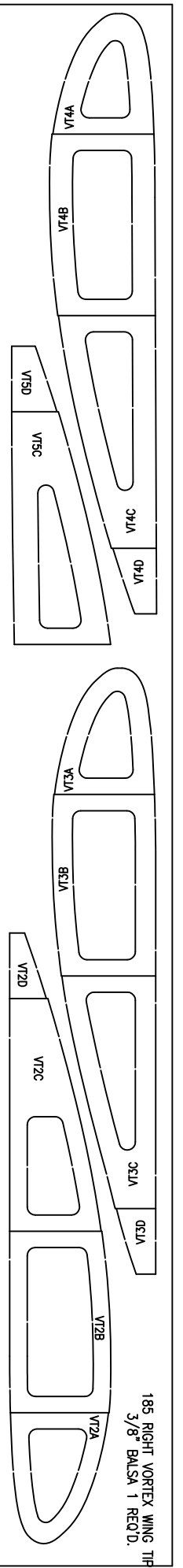

4" WIDE x 36" LONG x 3/8" THICK Balsa ONE (1) REQUIRED
FOR OPTIONAL VORTEX WING TIPS IF ORDERED

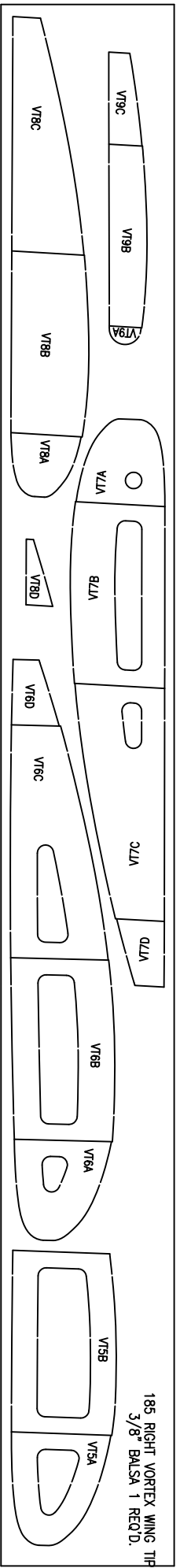

4" WIDE x 36" LONG x 3/8" THICK Balsa ONE (1) REQUIRED
FOR OPTIONAL VORTEX WING TIPS IF ORDERED

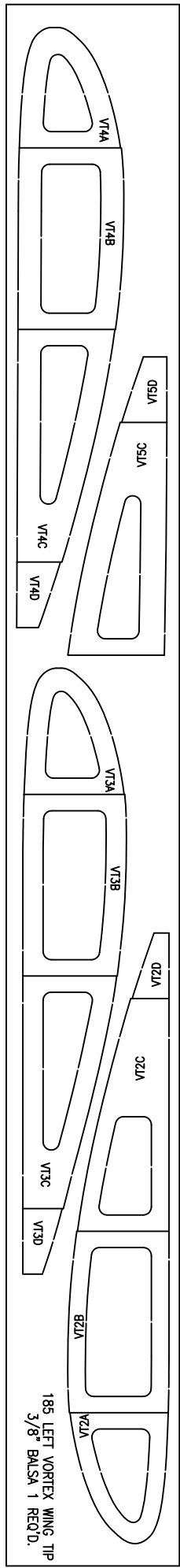

4" WIDE x 36" LONG x 3/8" THICK Balsa ONE (1) REQUIRED
FOR OPTIONAL VORTEX WING TIPS IF ORDERED

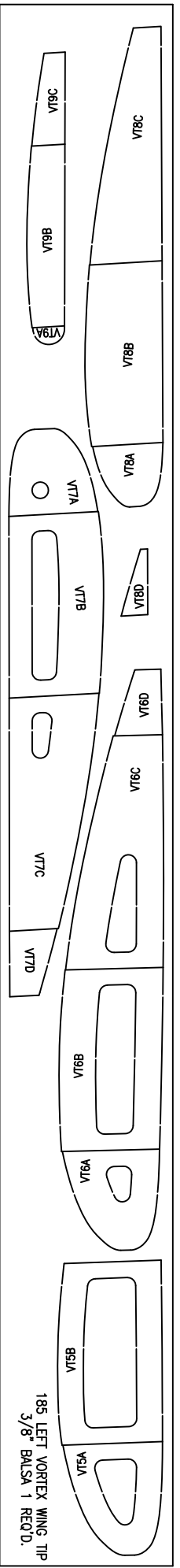

4" WIDE x 36" LONG x 3/8" THICK Balsa ONE (1) REQUIRED
FOR OPTIONAL VORTEX WING TIPS IF ORDERED

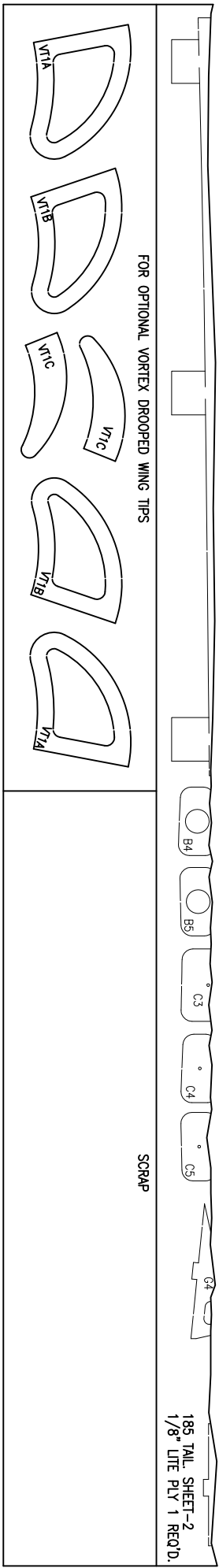

12" WIDE x 36" LONG x 1/8" THICK LITE PLY ONE (1) REQUIRED